

**PROGRAMMABLE
ASTRONOMICAL
TIMER WITH WI-FI
EM-130**



Operating Manual

Quality Management System of the device designing and production complies with the requirements of ISO 9001:2015

Dear Customer,

Novatek-Electro Ltd. Company thanks you for purchasing our products. You will be able to use properly the device after carefully studying the Operating Manual. Keep the Operating Manual throughout the service life of the device.

PURPOSE

The EM-130 programmable astronomical timer (hereinafter referred to as the Timer, EM-130) is a microprocessor device connected to Wi-Fi, which is designed to automate the street lighting switching on (poles, lanterns, etc.), illumination of building facades (adjacent territories, parking lots and other objects), heating devices, pumps, fans, and school bells ringing.

EM-130 provides the ability to configure parameters remotely via the built-in Web-interface (using a phone browser, a tablet, etc.), Modbus TCP or a remote Overvis server.

EM-130 automatically calculates the time of sunrise and sunset based on the entered coordinates and the current time enabling controlling lighting without using external sensors.

EM-130 can be used for load management depending on real-time without the need for continuous maintenance.

EM-130 is equipped with its own Wi-Fi access point, which enables direct connecting to the Timer using a mobile device with Wi-Fi and a browser.

You will start saving energy and your money by using EM-130 to control your lighting or heating appliances according to a preplanned schedule.

EM-130 features:

- Sunrise and sunset load management (astronomical control);
- Automatic load management according to a user-defined schedule;
- Real-time clock with a power reserve of at least 10 days (if there is no external power supply), without the use of built-in batteries;
- Manual load management via the Web-interface, Modbus TCP or Overvis server;
- Weekly working hours;
- Status indicator;
- One control button;
- Three main modes of Wi-Fi operation (network client, access point, or disabled);
- Time synchronization with the user's device (phone, tablet, etc.) or with the NTP exact time server;
- Saving the schedule to a file;
- Loading a schedule from a file;
- Intuitive Web-interface;
- Remote access to the product from the Overvis server from anywhere in the world where there is an Internet connection;
- Connecting the product to the SCADA system using the Modbus TCP protocol;

- Two switching groups of synchronously operating contacts allowing you to connect a load of up to 6 A per contact group.

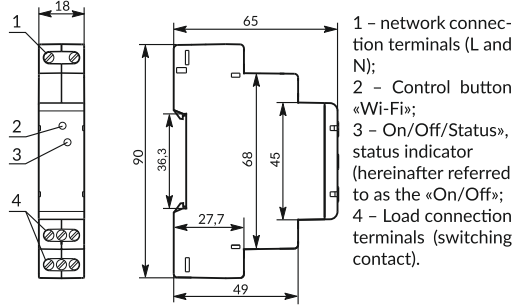

Figure 1

Display of «On/Off» indicator states:

- Always on – load is on;
- Blinks slowly (1.0-s period) – the user holds down the «Wi-Fi» button;
- Blinks slowly (0.5-s period) – connecting to a Wi-Fi access point;
- Fast blinking (period 0.15 s) – executing a command from the button on the front panel;
- Fast single blink every 5 seconds – the load is disabled and Wi-Fi is disabled;
- Fast double blinking every 5 seconds – the load is disabled, Wi-Fi is in the «network client» mode;
- Fast triple blinking every 5 seconds – the load is disabled; Wi-Fi is in the «access point» mode.

OPERATION CONDITIONS

The Timer is intended for operation in the following conditions:

- Ambient temperature: from minus 30 to +55 °C;
- Atmospheric pressure: from 84 to 106.7 kPa;
- Relative humidity (at temperature of +25 °C): 30 .. 80 %.

ATTENTION! The timer is not intended for operation in the following conditions:

- Significant vibration and shocks;
- High humidity;
- Aggressive environment with content in the air of acids, alkalis, etc., as well as severe contaminations (grease, oil, dust, etc.).

ACCEPTANCE CERTIFICATE

EM-130 has been manufactured and accepted in accordance with the requirements of valid technical documentation and classified as fit for operation.

Head of QC _____ Date of manufacture _____

Seal _____

TECHNICAL SPECIFICATIONS

Rated power supply voltage	220 – 240 V
Power supply frequency	45 - 65 Hz
Voltage at which operability is maintained	100 - 275 V
Maximum switching load current	6 A. (per contact)
Power of the connected load, no more:	
• AC-1, AC-7a – low inductive load, appliance load	≤ 1.44 kW
• AC-6a, AC-6b – daylight lamps	≤ 0.2 kW
• AC-5b – incandescent lamps	≤ 0.5 kW
• AC-7b – engines, transformers	≤ 0.2 kW
Readiness time when the power supply voltage is applied	≤ 2.0 s
Real-time clock accuracy ¹	±1.5 s/day
Real-time clock power reserve ²	≥ 10 days
Time correction possibility	±20.9 s/day
Accuracy of planned events	1 min.
Wi-Fi frequency	2.412-2.484 GHz
Wi-Fi Supported standards	IEEE 802.11 b/g/n
Wi-Fi encryption protocol	WPA2/PSK
Antenna type	In-built
Time synchronisation with the NTP server	Available
Time synchronisation with the local device	Available
Modbus TCP protocol support	Available
Support of connection to Overvis server	Available
Maximum number of events (schedule)	1024
Timer designation	Control and distribution equipment
Rated mode of operation	Lengthy
Climatic version	NF 3.1
Timer protection degree	IP 20
Switching resource of output contacts:	
- electrical	≥ 100 000 times
- mechanical	≥ 1 mln. times
Power consumption (under load)	≤ 1.5 W
Permissible degree of contamination	II
Overvoltage category	III
Class of electric shock protection	II
Insulation rated voltage	450 V
Rated pulse withstand voltage	4.0 kV
Tightening torque of the terminal block screws	0.4±0.1 N*m
Weight	≤ 0.08 kg
Overall dimensions, HxBxL	See Fig. 1
Timer installation (mounting) – standard 35 mm DIN rail	
The Timer retains its functionality at any position in space	
Case material: self-extinguishing plastic	
The Timer meets the requirements of the following:	
EN 60947-1; EN 60947-6-2; EN 55011; EN 61000-4-2	
Harmful substances in an amount exceeding the maximum permissible concentrations are absent	
¹ – provided that synchronisation with the NTP exact time server is enabled and Internet access is available;	
² – on condition that the Timer has been online for at least 2 hours.	

NTP – means a network protocol for synchronizing internal clocks using networks;

SR – SR means the sunrise (the moment when the upper edge of the solar disk appears above the horizon);

SS – means the sunset (the moment when the upper edge of the solar disk disappears below the horizon);

RT – means real time;

MON, TUES, WED, THURS, FRI, SAT, SUN – mean the abbreviated names of days of the week (Monday, Tuesday, etc.);

On default - means preset parameter values that the Timer uses in its operation until the user explicitly changes these values;

Web interface - means a system for the user's interaction with the Timer via the computer browser;

Browser – means application software designed for requesting, processing, manipulating, and displaying the content of web sites.

PRINCIPLE OF OPERATION

The Timer's principle of operation is based on switching the load on/off according to the user's pre-set schedule for the entire week (7 days).

A maximum of 1024 events can be set in EM-130 with an accuracy of 1 minute, which the user can distribute over the entire week (7 days) at their discretion

As a single program event, the user sets:

- The start time of the event (from 00 h : 00 m to 23 h : 59 m) or the time offset relative to sunrise or sunset (±11 h : 59 m);
- Load relay status (enabled or disabled).

Each day, the timer calculates the time of sunrise and sunset and adjusts the time of the event associated with it.

Then, the event time is compared with the internal real-time clock and, if they are equal or the event time is greater than the real time, the Timer will enable/disable the load depending on the state specified in the event.

The above algorithm is performed for each user-defined event. However, if there are more 1 events, only the event that is closest to the real-time clock will trigger, and other events will not be executed.

At latitudes where the polar day has occurred, events related to sunset will not be performed, and the time of sunrise is assumed to be 00 h : 00 m.

At latitudes where the polar night has occurred, events related to sunrise will not be performed, and the sunset time is assumed to be 00 h : 00 m.

Figure 2 shows an example of an astronomical programme where the schedule is set for the whole week – 4 events for each day, for street lighting – 4 hours after sunset and 4 hours before dawn, the rest of the time the lighting is turned off.

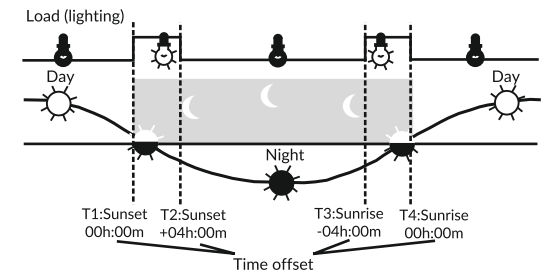

Figure 2

TERMS AND ABBREVIATIONS

Wi-Fi – means a family of standards for transmitting digital data streams over radio channels;

Figure 3 shows an example of a weekly program, where the schedule is set for the entire week and includes fourteen events to enable and disable the load every day at a certain time.

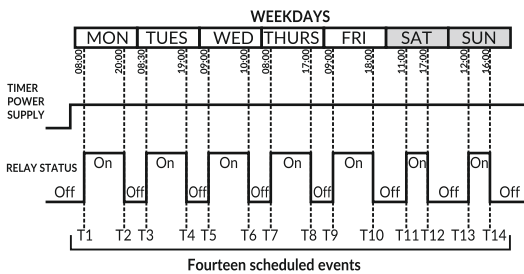

Figure 3

THE TIMER OPERATION

When describing the operation of the Timer, the default settings are used.

After connecting EM-130 to the power supply network, its parameters are initialized for 2 seconds, then the timer begins to turn on/off the load according to the schedule set by the user.

Note - after 2 seconds, if the schedule is not set and manual control is disabled, the load remains disabled.

Besides, after EM-130 is connected with the supply network, the timer Wi-Fi switches to the mode set by the user («Wi-Fi access point», «Wi-Fi network client» or «Wi-Fi is OFF»).

Depending on the chosen Depending on the selected settings, the Web-interface of the timer (on port 80) or the Modbus TCP server (on port 502) is started.

If the timer operates in the «Wi-Fi network client» mode, and there are connections to the «Internet», then:

- Time synchronization with the NTP server is performed every 2 hours (provided that synchronization is enabled in the timer settings);
- A connection is being made to the Overvis server (provided that the connection is enabled in the timer settings) - to provide remote access from the «Internet» to the timer.

When a manual control command is received (from the Web interface via the Modbus TCP protocol or the Overvis server), the execution of the currently scheduled event is blocked, the load is turned off (or turned on depending on the command), and the EM-130 switches to manual control mode (disable manual control to return the timer to the scheduled operation mode).

WI-FI OPERATING MODES

The Timer's Wi-Fi can operate in four modes (three main and one additional intended for configuration):

- Wi-Fi Access Point Mode;
- Wi-Fi network client mode;
- Mode without using Wi-Fi;
- Wi-Fi connection setup mode.

Wi-Fi Access Point Mode. EM-130 creates its own access point with the name and password specified by the user during setup.

The user, upon connecting to this access point, and in the browser (Opera, Chrome, Fire Fox, etc.), after going to «<http://192.168.4.1>», gets access to the management and set-tings of EM-130.

To the user-defined access point and starts all enabled services (Web-interface, Modbus TCP, and Overvis client).

The management and settings of EM-130 can be accessed via Modbus TCP, the Overvis client, or the Web-interface at the IP address issued to the timer by the router when connecting (for information on how to get the data on the current issued address, please refer to the Operating Instructions for the corresponding router).

The Wi-Fi Client Mode. EM-130 automatically connects to the

user-defined access point.

If there is no Wi-Fi connection, the EM-130 will automatically try to connect again every 10-15 seconds.

Mode without using Wi-Fi. EM-130 disables Wi-Fi and does not use it for the entire duration of its operation.

To access the Timer's settings, switch over to the Wi-Fi connection settings mode (see «Wi-Fi connection setting up»).

Wi-Fi Connection Setup Mode. EM-130 creates its own access point with the name «EM-130_xxxxxx» (where xxxxxx - is the unique Timer's code) and password «00000000».

The user, upon connecting to this access point, and in the browser (Opera, Chrome, Fire Fox, etc.) after going to «<http://192.168.4.1>», gets access to the Timer's settings.

CONNECTING THE TIMER

There is life-threatening voltage on the terminals and internal elements of the Timer.

The timer is not intended for short-circuit load switching, therefore, the Timer must be operated in an electrical network protected by a class "B" circuit breaker with a cut-off current of no more than 6A.

DO NOT connect a load of more than 1.44 kW to the Timer.

All connections must be made when the product is de-energized. DO NOT leave bared wire sections protruding beyond the terminal block.

To ensure the reliability of electrical connections, use flexible (multi-wire) wires for a voltage of at least 450 V, the ends of which must be stripped of insulation by 5±0.5 mm and compressed with bushing tips. Fixing the wires must prevent mechanical damage, twisting and erasing of the wires' insulation.

The wire cross-section for connecting a load of 1.44 kW must at least be 1.0 mm².

For reliable contact, tighten the terminal block screws with a force of 0.4 N*m.

When the tightening torque is reduced, the connection point heats up, the terminal block may melt and the wire may catch fire. If the tightening torque increases, it is possible that the thread of the terminal block screws break or the connected wire gets pinched.

TO AVOID MALFUNCTIONS, PLACE THE TIMER AS FAR AWAY AS POSSIBLE FROM DEVICES THAT GENERATE HIGH-FREQUENCY OR INDUCTION RADIATION (FOR EXAMPLE, CONTACTORS, RF FURNACES, WELDING MACHINES, MACHINES, OR DEVICES THAT USE PULSED VOLTAGES).

1. Turn off the mains voltage using the circuit breaker.
2. Connect the Timer according to the wiring diagram and

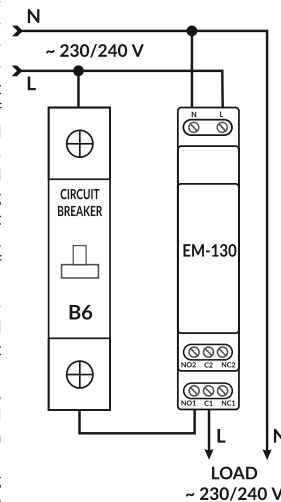

Figure 4

-2-

check that the connection is correct.

3. Turn on the circuit breaker.

4. Configure the Wi-Fi connection as described in the section «WI-FI CONNECTION SETTING UP».

CONTROLLING THE «WI-FI» BUTTON

The «Wi-Fi» button (Fig. 1, item 2) is used to control the Timer from the front panel.

When the «Wi-Fi» button is pressed and held, the «On/Off» indicator (Fig. 1, item 3) starts flashing with a period of 1 second helping to count down the time of holding the button.

When the button is released, the command depending on the button holding time starts to be executed, and the «On/Off» indicator starts flashing with a period of 0.15 seconds for 3 seconds.

All possible commands and holding times for the «Wi-Fi» button are listed below.

Holding time, s	Command
1 - 3	Restart the timer
5 - 8	Switches the Timer over to the Wi-Fi connection setup mode
10 - 15	Reset to factory settings
> 15	No actions will be carried out

WI-FI CONNECTION SETTING UP

To enter the Wi-Fi connection setup mode, use a thin nonmetallic object (for example, a toothpick) and press and hold the «Wi-Fi» button on the front panel of the Timer (Fig. 1, item 2) for 5-8 seconds.

After 5-8 seconds, release the button. In this case, the «On/Off» status indicator will start blinking rapidly (period 0.15 seconds) for 3 seconds.

The Timer will create the access point named «EM-130_xxxxxx», where xxxxxx is the unique Timer's code (see «The Timer's Main Screen»).

Use an electronic device (PC with Wi-Fi, phone, tablet, laptop, etc.) to connect to the access point using the following parameters:

- Access point name «EM-130_xxxxxx»;
- Password «00000000».

NOTE: To force exit from the setup mode, press and hold the «Wi-Fi» button on the front panel of the Timer for 1-3 seconds. Release the button and the status indicator will flash rapidly; the Timer will automatically restart.

Launch the browser (Chrome, Opera, Fire Fox, etc.) on an electronic device. Enter «<http://192.168.4.1>» in the browser's address bar and follow the link you entered.

The screen of the electronic device will display the Web-interface of the Timer and prompt you to enter the password (The Timer password entry screen).

Enter «admin» in the «PASSWORD» field, and click «Login».

After going to the main screen press the «MENU» button.

Then, select «SETTINGS» in the menu.

Configure the Timer's Wi-Fi:

- **Network name (SSID)** - is the name of the Wi-Fi network;
- **Network password** - is the password for the Wi-Fi network;
- **Working mode** - is the Timer's Wi-Fi mode;
- **IP settings** - are the settings for the IP address, subnet mask, and gateway address (which are automatically configured by the DHCP server by default);

- **MAC address** - is the unique address of the Timer;

- **IP address** - is the current IP address of the Timer;

- **Channel** - the current frequency channel of Wi-Fi operation.

To save the settings, click the «Save» button.

When the settings are saved, the screen of the electronic device will display a message about the successful saving of the settings and requesting to restart the Timer.

If necessary, configure the remaining parameters.

Restart the Timer by clicking the «Reboot device» button at the bottom of the page.

If the «Working Mode» was specified as a Wi-Fi client, wait for the EM-130 to connect to the specified Wi-Fi (the status indicator will stop flashing blue frequently).

CONNECTING TO THE TIMER VIA THE LOCAL WI-FI NETWORK

Control and configuration via a local Wi-Fi network is only possible after preconfiguring the Wi-Fi connection (see «Wi-Fi connection setting up») and enabling remote access via the Web-interface in the product settings.

In the router settings, you must reserve the IP address of the product by its MAC address (see the Operating Instructions for the router). Or when setting up a Wi-Fi connection, you need to set the «Custom» in the «IP Settings» field and specify static settings:

- IP address - is an unoccupied address in your network (for example: 192.168.0.105 or 10.0.0.5);
- Subnet mask - is your subnet mask (example: 255.255.255.0 or 255.0.0.0);
- Main gateway - is your router's IP address (example: 192.168.0.1 or 10.0.0.1);
- DNS1 - is the primary name server (example: 208.67.222.222);
- DNS2 - is the secondary name server (example: 8.8.8.8).

Enter the link «<http://192.168.0.105>» in the address bar of the browser (Chrome, Opera, Fire Fox, etc.) of the electronic device (PC, laptop, mobile phone, tablet, etc.) and follow it (where 192.168.0.105 is a specified static IP address of the Timer, which may be reserved on the router).

When the password entry page will be displayed (The Timer password entry screen) on the screen of the timer, from which the transition was performed, enter the password («admin», by default) and click «Login».

The Timer password entry screen

When you log in to the Timer's Web-interface, you must enter its password.

To do this, enter the password value in the «PASSWORD» field (by default, «admin») and click the «Login» button.

If the entered password is correct, the «PASSWORD» field will be highlighted in green and the user will see the main screen of the web interface.

If the entered password is incorrect, the «PASSWORD» field will be high-lighted in red.

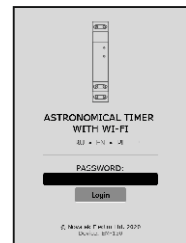
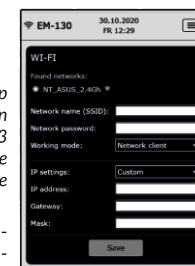
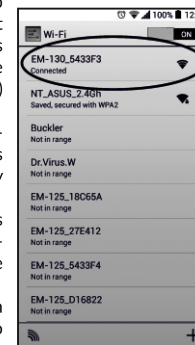

The Timer's Main Screen

The main screen provides full control over the Timer and the access to all its functions.

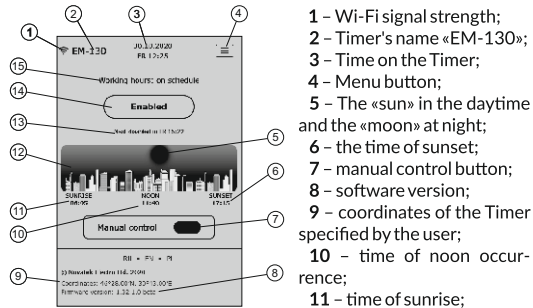

- 1 - Wi-Fi signal strength;
- 2 - Timer's name «EM-130»;
- 3 - Time on the Timer;
- 4 - Menu button;
- 5 - The «Sun» in the daytime and the «moon» at night;
- 6 - the time of sunset;
- 7 - manual control button;
- 8 - software version;
- 9 - coordinates of the Timer specified by the user;
- 10 - time of noon occurrence;
- 11 - time of sunrise;

- 12 - approximate position of the sun relative to the horizon;
- 13 - information about the next event;
- 14 - the current state of the load and the button of manual enabling/disabling the load;
- 15 - the current operating mode and information about errors in the Timer operation.

The Timer's Menu Screen

The Timer's menu screen enables access to various settings of the Timer.

- State** - transition to the main screen;
- Schedule** - viewing and configuring the current schedule;
- Settings** - the timer's parameters settings;
- Logout** - exit from Web-interface.



The Settings Screen of the Timer

The settings screen is divided into groups, where each group is responsible for its own set of parameters.

- Security** - setting the Timer password;
- Wi-Fi** - the Timer's Wi-Fi connection settings;
- Date and Time** - settings for date and time, time zone, time correction, and time synchronisation;

Location - settings of coordinates («latitude» and «longitude») of the Timer location (used in calculations of the sunrise and sunset).

At the bottom of the page there are the Timer reset button, the factory reset button and the schedule memory-clearing button.

The Timer's Schedule Screen

The schedule screen is divided into two parts and enables the creation, editing and viewing the current schedule of the Timer.

In the upper part there is a tabular list of all events and the event management buttons:

- New event** - adding a new event;
- Add from file** - adding the previously saved event list from the file to the current list.
- Save to file** - saving the current event list in the file;
- Delete event** - selective events deletion;
- Refresh** - refreshing the current event list from the Timer.

There is the weekly schedule for enabling the load in the lower part of the page.

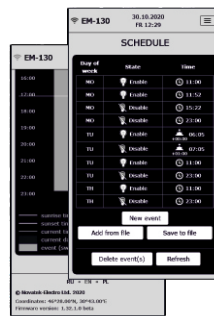

CONNECTING TO THE EM-130 VIA MODBUS TCP

Control and configuration via Modbus TCP is only possible after preconfiguration Wi-Fi connections (see «Wi-Fi connection setting up») and enabling the remote access via Modbus TCP in the Timer settings.

The Modbus TCP communication protocol allows you to connect EM-130 to the network organized according to the Ethernet standard. Using EM-130 in the network allows you to perform the following functions:

- Data collection in SCADA systems;
- Programming EM-130 via a PC (using specialized programs that work with the Modbus TCP protocol);
- Remote control of EM-130 within the local network.

When connecting to EM-130, access to the command register and the write-in function is blocked (the read function is not blocked). To unlock the register of command and the write-in function, insert the access code in ASCII characters (default value: «admin») in registers 101 - 164. Write zero values (0000h) in unused registers.

If the access code value is correct, EM-130 will unlock access to the register of command and the write-in function.

The EM-130 is controlled via the command register (see Appendix A «Addresses of registers for Modbus TCP protocol», of the EM-130 Operation Manual, posted on the website www.novatek-electro.com).

After changing the settings is completed, write the value 51930 in the Command Register (a record for the non-volatile (flash) memory). For the changes to take effect, write the value 17513 to the command register (EM-130 restart).

If the write-in functions or access to the command register are not used for a long period of time, block access to them by writing a value other than the access code (for example, 0000h) in registers 101 - 164.

If there is no data exchange within 60 seconds, EM-130 automatically breaks the connection with the client.

In EM-130, all values with a dot are represented as integers. Therefore, additional mathematical operations must be applied when processing the data.

Before writing a value with a dot to EM-130 (for example: 1.000), convert it to an integer by multiplying the value by a factor (1000), and then the result may be written to EM-130.

On a request to read the value with a dot (for example: 1.000), EM-130 returns an integer (1000). To convert the integer to the correct form, divide this number by the conversion factor (1000).

The conversion factor to an integer is determined by the number of decimal places (1.0 - 10; 1.00 - 100; 1.000 - 1000).

List of supported functions (Modbus):

- 03 h - Read one or more registers (maximum 125);
- 06 h - Single register entry;

-3-

- 10 h - Record of one or more registers (maximum 123).

Attention! EM-130 has a limitation on the number of Modbus TCP clients connected at the same time (no more than four). All connections that exceed the limit will be closed automatically.

CONNECTING TO THE EM-130 VIA THE OVERVIS SERVER

Overvis is a system for monitoring, visualization and remote control of technological processes.

Overvis allows you to:

- read data from devices including the recorder;
 - perform round-the-clock periodic data reading;
 - save data automatically to your own database;
 - view data in a convenient form;
 - receive alerts about accidents in the form of SMS or E-Mail.
- Information that is more detailed can be found on the official website www.overvis.com.

The Overvis system acts as a server for collecting data from EM-130 and other devices connected simultaneously, and provides real-time data access only with the permission of the EM-130 owner.

The Manufacturer's settings of EM-130 are prepared for connecting to the Overvis server, while the Overvis client themselves are disabled in EM-130 and must be activated manually by the User.

To connect EM-130 to the Overvis server:

- connect EM-130 to a Wi-Fi network with the available "Internet";
- Enable the Overvis client in the remote access settings;
- In the remote access settings, make sure that the connection to the server is established and the activation code is received;

OPTION 1:

- Scan the QR code (pasted on the side of EM-130) and click on the received link;

- Create or log in to your account;

OPTION 2:

- Go to the site «<https://overvis.com>»;

- Create or log in to your account;

- Add a new network by filling in the required fields:

- «Name» means the name of the network being created (for example, EM-130 network);
- «Modbus TCP Device» - Novatek-Electro EM-130;
- «Connection type» - Reverse connection with activation code;

▫ «Activation code» - specify the activation code from the EM-130 settings;

▫ «Password for requesting changes to the device parameters in the network» - specify the device password from the EM-130 settings.

- Add a new device by filling in the required fields:

- «Name» - the product name (for example, EM-130);
- «Modbus ID» - 1;
- «Initiate from template» - Novatek-Electro EM-130.

Note - If at the first connection of EM-130 to the Overvis server the activation code value indicates that the connection has already been activated, for security reasons, we recommend you to click the «Reset Activation Code» button to remove EM-130 from the Overvis system. This ensures that the plugged-in EM-130 will only be used by eligible users.

CONNECTING TO THE TIMER IN THE WI-FI ACCESS POINT MODE

Connect to a Wi-Fi hotspot with the help of an electronic device (PC with Wi-Fi, phone, tablet, laptop, etc.) using the Wi-Fi name and password earlier specified by the user when configuring the Timer (see «Wi-Fi connection setting up»).

Enter the link «<http://192.168.4.1>» in the electronic device browser address bar (Chrome, Opera, Fire Fox, etc.) and navigate through it.

When the password entry page will appear on the screen of the timer, from which the transition was made enter the password («admin», by default) and click «Login».

CONNECTING TO THE TIMER IN THE NONE-WI-FI MODE

You cannot connect to the Timer in the none-Wi-Fi mode.

To restore connection to the Timer, configure Wi-Fi according to the section «Wi-Fi connection setting up».

REAL-TIME CLOCK CORRECTION

Correction of the real-time clock enables compensating for the time lost by the real-time clock due to the influence of external factors on the Timer (such as temperature, humidity, etc.) within one day, from minus 20.9 s to +20.9 se-conds.

Correction of the clock is performed in the group of parameters «Date and Time».

Example: If the clock is 4.2 seconds slow per day, you must specify a correction value of +4.2 seconds, and if the clock is 4.2 seconds fast, you must specify a correction value of minus 4.2 seconds.

REBOOT THE TIMER

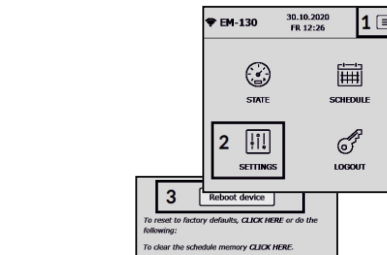

Using a thin non-metallic object (such as a toothpick), press and hold the «Wi-Fi» button for 1-3 seconds on the front panel of the Timer. In this case, the «On/Off» indicator will flash rapidly (0.15 s) for 3 seconds, and the Timer will automatically restart.

Release the «Wi-Fi» button. In this case, the «On/Off» indicator will flash rapidly (0.15 s) for 3 seconds, and the Timer will automatically restart.

Note: you can perform a reboot from the Timer's Web interface by going to settings and clicking the «Reboot device» button (items 1, 2 and 3).

RESETTING TO FACTORY SETTINGS

Using a thin non-metallic object (such as a toothpick) press and hold the «Wi-Fi» button for 10-15 seconds on the front panel of the Timer. In this case, the «On/Off» indicator will start flashing every second (helping to count down the time).

Release the «Wi-Fi» button. In this case, the «On/Off» indicator will start flashing rapidly (a period of 0.15 seconds).

When the operation has been completed, the status indicator will stop flashing and the Timer will automatically restart.

The Timer has been reset to factory settings and is ready for use.

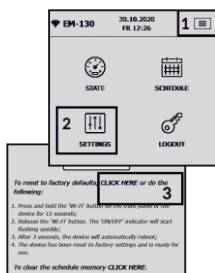

Notes:

1 – reset can be performed from the Timer's Web-interface by going to the settings and clicking the «CLICK HERE» link, as shown in Figure (items 1, 2 and 3);

2 – the schedule made up by the user remains unchanged.

CLEARING THE SCHEDULE

Resetting the schedule is only possible from the Timer's Web-interface.

Go to the Timer's settings and click the «CLICK HERE» link as shown in the picture (items 1, 2 and 3).

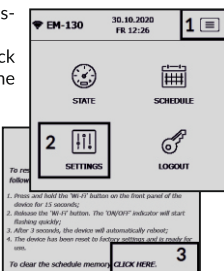

Creating a Schedule

On the main screen of the Web-interface, click the menu button «☰». Then, in the menu select «SCHEDULE».

On the schedule screen, click the «New event» button, and the screen will display the input field for the new event.

In EM-130, you can create two types of events, normal, or associated:

- normal event implies one event – enable (or disable) the load at the specified time;

- associated event involves two actions – turn on the load at the specified time, and then turn off the load at the specified time. In this case, the turn-on time should be less than the turn-off time.

Note – If the sequence of actions in the associated event is broken (the turn-on time becomes longer than the turn-off time, for example, due to different sunrise/sunset times in summer and in winter), the execution of such an event gets blocked and the event in the list is marked with a sign «🔒».

Switching between a normal event and an associated event is performed by the parameter «This is a related event».

Custom event fields:

- «CONDITION OF LOADING» – the action that will be performed by the event (enabling / disabling the load);

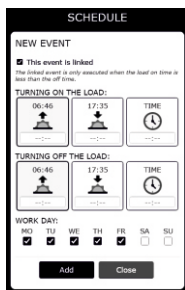

- «TRIGGER TIME» – the time when the event is triggered;
- «TRIGGER DAYS» – the event trigger days;
- «LOAD ON» – the time when the load of the associated event is turned on;
- «LOAD OFF» – the time when the load of the associated event is turned off.

Depress the «Add» button to add an event.

Depress the «Close» button to quit the event-adding mode.

EM-130 CONFIGURABLE PARAMETERS (for Web-interface)

Description	Range		Value after reset
	from	to	
SAFETY			
The Timer password	64 symbols ASCII		admin
Wi-Fi			
Network name (SSID)	32 symbols ASCII		EM130_XXXXXX
Network password	64 symbols ASCII		00000000
Wi-Fi operating mode	Network client Access point Disabled		Disabled
Settings TCP/IP	Manually / Automatically		Automatically
IP address	0.0.0.0	255.255.255.255	192.168.0.105
Subnet mask	0.0.0.0	255.255.255.255	255.255.255.0
Default gateway	0.0.0.0	255.255.255.255	192.168.0.1
DNS1	0.0.0.0	255.255.255.255	208.67.222.222
DNS2	0.0.0.0	255.255.255.255	8.8.8.8
MAC-address	Unique MAC-Address of the Timer		
IP-address	Current IP-Address of the Timer		
DATE AND TIME			
Greenwich time zone (GMT)	UTC-12:00	UTC+13:00	UTC+2:00
Time correction, s	-20.9	+20.9	+0.0
Automatic changing to summer time and back	No / Yes		No
Time synchronisation	Disabled / Enabled		Enabled
NTP server address	32 symbols ASCII		«time.windows.com»
Connecting port	1	65535	123
LOCATION			
Latitude	Northern (N)	Southern (S)	Northern (N)
Coordinates	+90°	-90°	+50° 27'
Longitude	Eastern (E)	Western (W)	Eastern (E)
Coordinates	+180°	-180°	+30° 30'
Day/night borderline	Visible sunset End of civil twilight End of nautical twilight End of astronomical twilight		End of civil twilight
REMOTE CONTROL			
Web-interface turning on	No / Yes		Yes
Port of Web-interface	1	65535	80

-4-

Description	Range		Value after reset
	from	to	
Modbus TCP turning	No / Yes		No
Port Modbus TCP	1	65535	502
Overvis turning on	No / Yes		No
Overvis server address	32 ASCII characters		«modbus.overvis.com»
Port of connection to Overvis	1	65535	20502

SAFETY PRECAUTIONS

DO NOT attempt to open or repair the Timer yourself.

DO NOT use the Timer with mechanical damage to the housing.

DO NOT allow water to get on the internal parts of the Timer.

To improve performance, it is recommended to use the Timer at load currents that do not exceed 70% of the maximum value.

In the operation and maintenance comply with:

«The Rules of Technical Operation of Household Electrical Installations»;

«Safety Rules of Operation of Household Electrical Installations»;

«Labour Protection when Operating Electrical Installations».

MAINTENANCE

ATTENTION! During maintenance it is necessary to disable the Timer and connected devices from the mains.

Recommended frequency of maintenance is every six months. Maintenance Procedure:

- 1) Check the connection reliability of the wires, if necessary, clamp;
- 2) Visually check the integrity of the housing, in case of detection of cracks and damages take the Timer out of service and send for repair;
- 3) If necessary, wipe the front panel and the housing of the Timer with cloth.

Do not use abrasives and solvents for cleaning.

SERVICE LIFE AND MANUFACTURER WARRANTY

The lifetime of the Timer is 10 years. Upon expiration of the service life, contact the manufacturer.

Shelf life is 3 years.

Warranty period of the Timer operation is 5 years from the date of sale.

During the warranty period of operation (in the case of failure of the Timer) the manufacturer is responsible for free repair of the Timer.

ATTENTION! IF the Timer has been operated with the violation of the requirements of this user manual, the user will lose the right to warranty maintenance.

Warranty service is performed at the place of purchase or by the manufacturer of the Timer.

Post-warranty service of the Timer is performed by the manufacturer at current rates.

Before sending for repair, the Timer should be packed in the original or other packing excluding mechanical damage.

TRANSPORTATION AND STORAGE

The Timer in the original package is permitted to be transported and stored at the temperature from minus 45 to +60 °C and relative humidity of no more than 80 %.

CLAIMS DATA

You are kindly requested, in case of the Timer return and transfer it to the warranty (post-warranty) service please indicate detailed reason for the return in the field of the claims data.

The Company is grateful to you for the information about the quality of the Timer and suggestions for its operation.

For all questions, please contact the manufacturer:

NOVATEK-ELECTRO Ltd,
59, Admiral Lazarev Str. ,
Odessa, 65007, Ukraine.
Tel.: +38 (048)738-00-28,
Tel./fax: +38 (0482) 34-36-73.
www.novatek-electro.com

VN220128

Date of sale _____

The EM-130 Operating manual is given on the website
www.novatek-electro.com

Appendix A. ADDRESSES OF REGISTERS FOR MODBUS TCP PROTOCOL

Description	Range		Value upon resetting	W/R	Register address	Type
	from	to				
IDENTIFICATION						
The Timer identifier	---	---	32	R	0	U16
Microprogram version	---	---	18	R	1	U16
MAC-address	---	---	Unique	R	10 - 15	U8
STATE						
Current level of Wi-Fi signal, in dBm	-128	127	---	R	16	S8
Current IP address	0	FFFFFFFFh	COA80401h (192.168.4.1)	R	17 - 18	U32
Web-interface service state: 0 - inactive; 1 - serving clients	0	1	0	R	19	U16
State of NTP service: 0 - inactive; 1 - executing DNS queries; 2 - synchronizes time; 3 - error	0	3	0	R	20	U16
State of Overvis service: 0 - inactive; 1 - executing DNS queries; 2 - executing connection to server; 3 - waiting for data from the server; 4 - error	0	4	0	R	21	U16
State of Modbus TCP service: 0 - inactive; 1 - serving clients	0	1	0	R	22	U16
Flags of the EM-130 state: bit:0 - «Wi-Fi network client» operating mode is ON; bit:1 - «Wi-Fi access point» mode is ON; bit:2 - load relay is ON; bit:3 - load relay manual control is ON; bit:4 - Web-interface service is started up; bit:5 - time and user's device are synchronized; bit:6 - time and server NTP are synchronized; bit:7 - Wi-Fi networks scanning is executed; bit:8 - polar night; bit:9 - polar day; bit:10 - Overvis service is started up; bit:11 - NTP service is started up; bit:12 - Modbus TCP service is started up bit:13 - Overvis full access; bit:14 - Modbus TCP full access				R	23 - 24	U32
Flags of the EM-130 errors: bit: 0 - Real time clock error; bit: 1 - the EM-130 settings are damaged				R	25 - 26	U32
DATE AND TIME						
Current time, seconds from 1970	0	FFFFFFFFh	---	WR	27 - 28	U32
Flag of summer time correction	0	1	0	R	29	U16
Sunrise time today, in seconds	0	86400	---	R	42 - 43	U32
Sunset time today, in seconds	0	86400	---	R	44 - 45	U32
Sunrise time on Mon, in minutes	0	1440	---	R	46	U32
Sunrise time on Tue, in minutes	0	1440	---	R	47	U32
Sunrise time on Wed, in minutes	0	1440	---	R	48	U32
Sunrise time on Thu, in minutes	0	1440	---	R	49	U32
Sunrise time on Fri, in minutes	0	1440	---	R	50	U32

Description	Range		Value upon resetting	W/R	Register address	Type
	from	to				
Sunrise time on Sat, in minutes	0	1440	---	R	51	U32
Sunrise time on Sun, in minutes	0	1440	---	R	52	U32
Sunset time on Mon, in minutes	0	1440	---	R	53	U32
Sunset time on Tue, in minutes	0	1440	---	R	54	U32
Sunset time on Wed, in minutes	0	1440	---	R	55	U32
Sunset time on Thu, in minutes	0	1440	---	R	56	U32
Sunset time on Fri, in minutes	0	1440	---	R	57	U32
Sunset time on Sat, in minutes	0	1440	---	R	58	U32
Sunset time on Sun, in minutes	0	1440	---	R	59	U32
EVENT (CURRENT)						
«Start-up time», in minutes	-1440	1440		R	30	S16
«Cut-off time», in minutes	-1440	1440		R	31	S16
«startup mode»: 0 - not used; 1 - sunrise time; 2 - sunset time; 3 - real time	0	3		R	32	U8
«Cut-off mode»: 0 - not used; 1 - sunrise time; 2 - sunset time; 3 - real time	0	3	0	R	33	U8
«Day of the week»: 0 - Mon; 1 - Tue; 2 - Wed; 3 - Thu; 4 - Fri; 5 - Sat; 6 - Sun	0	6		R	34	U8
«Type of event»: 0 - no event; 1 - event of start-up; 2 - event of cut-off; 3 - associated event	0	3		R	35	U8
EVENT (NEXT)						
«Start-up time», in minutes	-1440	1440		R	36	S16
«Cut-off time», in minutes	-1440	1440		R	37	S16
«Start-up mode»: 0 - not used; 1 - sunrise time; 2 - sunset time; 3 - real time	0	3		R	38	U8
«Cut-off mode»: 0 - not used; 1 - sunrise time; 2 - sunset time; 3 - real time	0	3	0	R	39	U8
«Day of the week»: 0 - Mon; 1 - Tue; 2 - Wed; 3 - Thu; 4 - Fri; 5 - Sat; 6 - Sun	0	6		R	40	U8
«Type of event»: 0 - no event; 1 - event of start-up; 2 - event of cut-off; 3 - associated event	0	3		R	41	U8

Description	Range		Value upon resetting	W/R	Register address	Type
	from	to				
THE EM-130 CONTROL						
Instructions register: 27964 - starting synchronization of time and NTP server; 17513 - the EM-130 resetting; 37841 - restore settings to comply with Manufacturer's ones; 51930 - save the settings in the flash memory; 31795 - download the settings from the flash memory; 17960 - start up the load control automatic mode; 17961 - start up the load; 17962 - cut off the load				WR	100	U16
Entering access code to the EM-130	ASCII string with NULL terminator		«admin»	WR	101-164	STR64
EVENTS CONTROL						
Instructions register: 3768 - read the first event into input/output registers; 5942 - read the next event into input/output registers; 500 - add an event from input/output registers; 505 - cancel the event coinciding with input/output registers; 599 - cancel all events; 10000..16143 - cancel the event with this address				WR	200	U16
Registers of event input-output:						
«Start-up time», in minutes	-1440	1440		WR	201	S16
«Cut-off time», in minutes	-1440	1440		WR	202	S16
«Start-up mode»: 0 - not used; 1 - sunrise time; 2 - sunset time; 3 - real time	0	3		WR	203	U8
«Cut-off mode»: 0 - not used; 1 - sunrise time; 2 - sunset time; 3 - real time	0	3	0	WR	204	U8
«Day of the week»: 0 - Mon; 1 - Tue; 2 - Wed; 3 - Thu; 4 - Fri; 5 - Sat; 6 - Sun	0	6		WR	205	U8
«Type of event»: 0 - no event; 1 - event of start-up; 2 - event of cut-off; 3 - associated event	0	3		WR	206	U8
«Adres wydarzenia»	10000	16142		R	207	U16
SETTINGS						
Correction of real time clock, in seconds * 10	-209	209	0	WR	500	S16
Time zone, in minutes	-720	780	120	WR	501	S16
Automatic transition to summer time and back	0	1	1	WR	502	U16
Load control: 0 - automatic, depending on events; 1 - load is initiated; 2 - load is OFF	0	2	0	WR	503	U16
Latitude, in seconds: Less than 0 - south latitude; Over 0 - north latitude	-324000	324000	167280	WR	504-505	U32

Description	Range		Value upon resetting	W/R	Register address	Type
	from	to				
Longitude, in seconds: Less than 0 - west longitude; Over 0 - east longitude; wschodnia	-648000	648000	110580	WR	506-507	U32
Zenith: 0 - visible sunset; 1 - end of civil twilight; 2 - end of nautical twilight; 3 - end of astronomical twilight	0	3	1	WR	508	U16
The EM-130 access code	ASCII string with NULL terminator		«admin»	WR	509-572	STR64
Wi-Fi operating mode: 0 - disabled; 1 - access point; 2 - network client	0	2	0	WR	573	U16
Wi-Fi frequency channel	1	13	1	WR	574	U16
Hide SSID Wi-Fi	0	1	0	WR	575	U16
Network parameters automatic setting (DHCP)	0	1	1	WR	576	U16
IP address	0	FFFFFFFFh	COA80065h (192.168.0.101)	WR	577-578	U32
Gateway	0	FFFFFFFFh	COA80001h (192.168.0.1)	WR	579-580	U32
Subnet mask	0	FFFFFFFFh	FFFFFFFF00h (255.255.255.0)	WR	581-582	U32
DNS 1 address	0	FFFFFFFFh	FFFFFFFF00h (255.255.255.0)	WR	583-584	U32
DNS 2 address	0	FFFFFFFFh	08080808h (8.8.8.8)	WR	585-586	U32
Wi-Fi network name (SSID)	ASCII string with NULL terminator		«EM130-xxxxxx»	WR	587-618	STR32
Wi-Fi network password	ASCII string with NULL terminator		«00000000»	WR	619-682	STR32
Enable Web-interface service	0	1	1	WR	683	U16
Web-interface service port	1	65535	80	WR	684	U16
Enable Modbus TCP service	0	1	0	WR	685	U16
Modbus TCP server port	1	65535	502	WR	686	U16
Enabling NTP service port	0	1	1	WR	687	U16
NTP server port	1	65535	123	WR	688	U16
NTP server address	ASCII string with NULL terminator		time.windows.com	WR	689-720	STR32
Enabling Overvis service	0	1	0	WR	721	U16
Overvis server port	1	65535	20502	WR	722	U16
Overvis server address	ASCII string with NULL terminator		modbus. overvis.com	WR	723-754	STR32
W/R - Write/Read; U8 - unsigned char (8 bits); S8 - signed char (8 bits); U16 - unsigned short (16 bits); S16 - signed short (16 bits); U32 - unsigned int (32 bits); S32 - signed int (32 bits); STR32 - ASCII string with a length of 32 characters; STR64 - ASCII string with a length of 64 characters						