



ACTIVE POWER OVERFLOW LIMITATION SYSTEM

EPS (Eco Profit Solutions)

OPERATING MANUAL

*Quality control system on the development and production complies with requirements
ISO 9001:2015*

Dear customer,

Company NOVATEK-ELECTRO LTD. thanks you for purchasing our devices.
You will be able to use properly the device after carefully studying the Operating Manual.
Keep the Operating Manual throughout the service life of the device.

ATTENTION! ALL REQUIREMENTS OF THIS OPERATING MANUAL ARE COMPULSORY TO BE MET!



TO ENSURE SAFE OPERATION OF THE SYSTEM, IT IS STRICTLY PROHIBITED TO:

- PERFORM INSTALLATION WORKS AND MAINTENANCE WITHOUT DISCONNECTING THE SYSTEM ELEMENTS FROM THE SUPPLY MAINS;
- OPEN AND REPAIR THE SYSTEM ELEMENTS BY YOURSELF;
- OPERATE THE SYSTEM ELEMENTS WITH MECHANICAL DAMAGE TO THE CASE;
- ALLOW WATER TO CONTACT WITH THE SYSTEM ELEMENTS.

ATTENTION!

- 1) **THE SYSTEM IS NOT INTENDED FOR LOAD SWITCHING IN SHORT CIRCUITS. THEREFORE, THE SYSTEM SHOULD BE OPERATED IN AN ELECTRIC NETWORK PROTECTED BY AUTOMATIC CIRCUIT BREAKERS WITH A CUTOFF CURRENT OF AT LEAST 63 A (FOR «EPS-MASTER») AND 16 A (FOR «EPS-SLAVE»).**
- 2) **IT IS FORBIDDEN TO CONNECT A LOAD AT POWER OVER 14.4 kW TO «EPS-MASTER», AND A LOAD WITH A POWER OVER 3.6 kW TO «EPS-SLAVE».**

It is recommended to use the system at load currents not exceeding 70% of the maximum value in order to improve operational characteristics.

During operation and maintenance the regulatory document requirements must be met, namely:

- Regulations for Operation of Consumer Electrical Installations;
- Safety Rules for Operation of Consumer Electrical Installations;
- Occupational Safety when in Operation of Electrical Installations.

Installation, adjustment and maintenance of the device must be performed by qualified personnel having studied this Operating Manual.

In compliance with the requirements of this Operating Manual and regulations the device is safe for use.



This Operation Manual is intended to get you acquainted with the device, safety requirements, the procedure for operation and maintenance of the active power flow limiting system «EPS» "Eco Profit Solution" (hereinafter referred to as «EPS», in case of reference to a specific device of the system: «EPS-Master» - main unit, «EPS-Slave» - executive unit).

The system «EPS» meets the requirements of:

- EN 60947-1;
- EN 60947-6-2;
- EN 55011;
- EN 61000-4-2.

Harmful substances in concentration more than allowed are absent.

Terms and abbreviations:

- ❖ **Wi-Fi** - a family of standards for transmitting digital data streams over radio channels;
- ❖ **NTP** – a network protocol for synchronizing the internal clock with use of networks;
- ❖ **RMS** - effective (root mean square) value;
- ❖ **AR** - automatic reclosing of the load;
- ❖ **By default** - the preset values of the parameters that the «EPS» uses in its work, until the user explicitly changes these values;
- ❖ **Web-interface** - a system of user interaction with the «EPS» through a computer browser.
- ❖ **Purple** –the color of the indicator obtained by mixing the blue and red glow.

1. PURPOSE

1.1. Purpose of the «EPS» device

The «EPS» is a complex multifunctional system consisting of several microprocessor devices connected to a home Wi-Fi network.

The «EPS» can be used in conjunction with systems of solar, wind, hydroelectric power generators in order to reduce power generated to the network by turning ON or OFF additional loads.

The «EPS» can operate as a power limiter, reducing the load on the wiring - by disconnecting the nonessential load.

The «EPS» consists of one «EPS-Master» and one or more (up to 5) «EPS-Slaves».

The «EPS-Master» and «EPS-Slave» store a log of their work for the last month and energy consumption data in their internal memory.

The «EPS-Master» and «EPS-Slave» are equipped with one control button (to enter the setup mode) and a two-color indicator (to display alarms and the status of connection to the home Wi-Fi network).

When the «EPS» is connected to the «my.overvis.com» cloud service, the control becomes possible from anywhere in the world where there is an Internet connectivity.

The «EPS-Master» has protection against overheating inside the case and disconnects the load if the temperature exceeds 80 °C (due to exceeding the rated current of the load, poor contact due to poor clamping of the terminal block screws, etc.).

Key features of «EPS»:

- Metering of consumed electric power;
- Metering of generated electric power;
- Metering of saved electric power;
- Work log for the last month;
- Measurement of voltage and frequency of the network;
- Measurement of current consumed by the load;
- Measurement of power consumed by the load;
- Load protection against emergency voltages in the mains;
- Protection against excess of the maximum current consumption;
- Protection against overheating of internal elements;
- Real-time clock with power reserve up to 5 days (in case of power failure);
- Automatic time synchronization with the exact time server (NTP);
- Remote access to the «EPS» via the «my.overvis.com» cloud.

1.2. Controls, overall and installation dimensions

Controls, overall and mounting dimensions are shown in Figures 1 and 2.

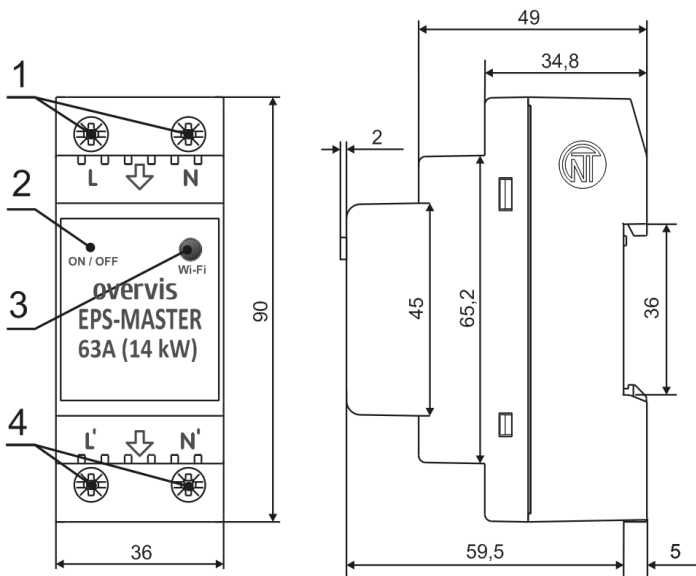

- 1 – Terminals for network connection (L and N);
- 2 – Status indicator «ON/OFF» (two-color: red/blue);
- 3 – «Wi-Fi» control button;
- 4 – Terminals for load connection (L 'and N').

Fig. 1 - Controls, overall and installation dimensions of the «EPS-Master»

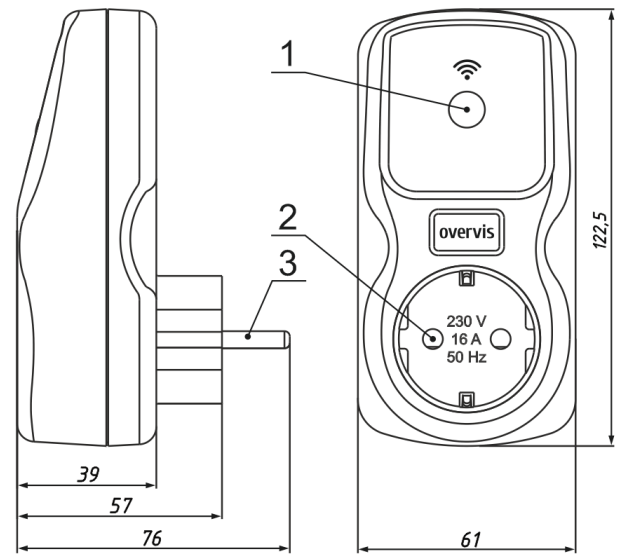

- 1 – «Wi-Fi» control button and «ON/OFF» status indicator (two-color: red / blue);
- 2 – «Socket» - to connect the load;
- 3 – «Plug» - to connect to the network;

Fig. 2 - Controls, overall and installation dimensions of the «EPS-Slave»

Status indication for the «EPS-Master» and «EPS-Slave»:

- Blue (flashing) – connects to your home Wi-Fi network;
- Blue (on) – the load is on, there is a connection to the home Wi-Fi network;
- Blue (flashes once every 5 seconds) – the load is off, there is a connection to the home Wi-Fi networks;
- Red (flashing) – the countdown of the re-closure time is in progress;
- Red (on) – trouble occurrence;
- Blue - red (flashing) – Wi-Fi connection setup mode is on;
- Purple (flashing) – search mode is on;
- Purple (on) – recovery of the factory settings, the software is being updated, or the «Wi-Fi» control button is pressed.

1.3. Operation conditions

The «EPS» is intended for operation in the following conditions:

- Ambient temperature: from minus 30 to +50 °C;
- Atmospheric pressure: from 84 to 106.7 kPa;
- Relative humidity (at temperature of +25 °C): 30 ... 80 %.

ATTENTION! The «EPS» is not intended for operation in the following conditions:

- Significant vibration and shocks;
- High humidity;
- Aggressive environment with content in the air of acids, alkalis, etc., as well as severe contaminations (grease, oil, dust, etc.).

2. TECHNICAL SPECIFICATIONS

2.1 Main technical specifications

The main technical characteristics of the «EPS-Master» and «EPS-Slave» are shown in Table 1.

The description of the «EPS-Master» web interface is given in Appendix A.

The adjustable parameters of the «EPS-Master» are shown in Table A1 - Appendix A.

The description of the «EPS-Slave» web interface is given in Appendix B.

The adjustable parameters of the «EPS-Slave» are shown in Table B1 - Appendix B.

Table 1 - Main technical specifications

Description	Values	
	«EPS-Master»	«EPS-Slave»
Rated supply voltage, V	220 – 240	
Power supply frequency, Hz	50/60	
Operating voltage, V	100 – 400	
Maximum switched current at active load, A	63	16
Power of the connected load, W, not more	14000	3600
Ready time when supplying voltage, s, no more	1.5	
Off-delay when voltage rises above 400 V, for the time exceeding 2.0 ms, no more	0.05	
Off-delay when voltage drops below the setting, s	12 ¹	
Off-delay when current exceeds the maximum value by 1 A, s	5 ¹	
Range of voltage measurement, V	100 – 350	
Accuracy of the mains voltage measurement, % (of the range)	± 1	
Range of current measurement, A	0.35 – 65	0.05 – 18
Accuracy of load current measurement, % (of the range)	± 2	
Range of power measurement, W	80 – 15600	10 – 4500
Accuracy of power measurement, % (of the range)	± 3	
Range of frequency measurement, Hz	45 – 65	
Accuracy of frequency measurement, Hz	± 0.03	
Accuracy of the real-time clock, s/day	± 1 ²	
Real-time clock reserve, days	Up to 5 ³	
Wi-Fi frequency, GHz	2.412 – 2.484	
Supported Wi-Fi standards	IEEE 802.11 b/g/n	
Wi-Fi encryption protocol	WPA2/PSK	
Protocol of time synchronization with the NTP server	yes	
Data exchange protocol with «my.overvis.com» server	yes	
Maximum log length, records	10000	
Log entry type	Along a ring	
Log recording period, min	5 ⁴	
Tightening torque of the terminal block screws, N*m	2±0.2	---
Purpose of the «EPS»	Switchgear and control-gear	
Rated operating condition	Long-continued	
Climate version	NF 3.1	
Protection class rating for «EPS»	IP 20	IP 30
Switching resource of output contacts: - electric number, not less - mechanical, number, not less	10 000 500 000	100 000 1 000 000
Power consumption (under the load), W, no more	2.5	
Permissible degree of contamination	II	
Overtoltage category	III	
Class of electrical shock protection	II	I
Rated insulation voltage, V	450	
Rated pulse withstand voltage, kV	4.0	
Mass, kg, no more	0.160	0.150
Overall dimensions	See Fig. 1	See Fig.2
«EPS» installation (assembling)	standard 35 mm DIN rail	Plug – Socket
«EPS-Master» and «EPS-Slave» retain their its operability in any position in space		
Material of the body frame - self-extinguishing plastic		
Notes:		
1 - fixed time;		
2 - provided that synchronization with the NTP server is enabled and there is access to the Internet,		
3 - provided that the device has worked from the mains for at least 1 hour,		
4 - troubles and changes in the state of relay contacts are saved immediately without waiting for the recording period		

2.2 Modes of operation for the «EPS»

The «EPS» can operate in the following modes:

- Overflow relay;
- Overflow relay with inversion;

- Power limiting relay;
- Power limiting relay with inversion;
- Setup of a Wi-Fi connection.

Overflow relay

It is used to reduce the electric power generated into the network by **switching on** additional loads. (*For example: turning on a boiler or electric heater when an excess of generated electric power is detected*).

The «EPS-Master» and «EPS-Slave» make connection to the home Wi-Fi network (user-defined), measure and control parameters of the electrical network (voltage, frequency, current, etc.) to protect the load and to meter electric power.

When an excess of generated electric power is detected, the «EPS-Master» sends a control command to the «EPS-Slave» – load connection.

When the generated electric power drops below the permissible threshold, the «EPS-Master» sends a control command to the «EPS-Slave» – load disconnection.

Overflow relay with inversion

It is used to reduce the electric power generated into the network by **turning off** additional sources of electric energy. (*For example: turning off the network micro-inverter when an excess of generated electric power is detected*).

The «EPS-Master» and «EPS-Slave» make connection to the home Wi-Fi network (user-defined), measure and control the parameters of the electrical network (voltage, frequency, current, etc.) to protect the load and to meter electric power.

When an excess of generated electric power is detected, the «EPS-Master» sends a control command to the «EPS-Slave» - disconnection of the additional power source.

When the generated electric power drops below the permissible threshold, the «EPS-Master» sends a control command to the «EPS-Slave» – connection of an additional source of electric power.

Power limiting relay

It is used to reduce the load on the electrical wiring by **disconnecting** secondary loads (*For example: turning off the boiler or washing machine when it detects that the power consumption threshold is exceeded*).

The «EPS-Master» and «EPS-Slave» make connection to the home Wi-Fi networks (user-defined), measure and control the parameters of the electrical network (voltage, frequency, current, etc.) to protect the load and to meter electric power.

When the power consumption exceeds the permissible threshold, the «EPS-Master» sends a control command to the «EPS-Slave» – load disconnection.

When the power consumption drops below the permissible threshold, the «EPS-Master» sends a control command to the «EPS-Slave» – load connection.

Power limiting relay with inversion

It is used to reduce the electrical power consumed from the network by turning on additional sources of power (*For example: turning on the network micro-inverter*).

«EPS-Master» and «EPS-Slave» make connection to the home Wi-Fi networks (user-defined), measure and control the parameters of the electrical network (voltage, frequency, current, etc.) to protect the load and to meter electric power.

When the power consumption exceeds the threshold, the «EPS-Master» sends a control command to the «EPS-Slave» – connection of an additional power source.

When the power consumption drops below the permissible threshold, the «EPS-Master» sends a control command to the «EPS-Slave» - disconnection of the additional power source.

Set-up mode for Wi-Fi connection

The «EPS-Master» and «EPS-Slave» create their own access point named «EPS-Master_XXXXXX» and «EPS-Slave_XXXXXX» respectively, where XXXXXX is a unique device code.

To obtain automatic Wi-Fi network settings, the «EPS-Slave» constantly scans Wi-Fi networks in search for the «EPS-Master», and when it is found, it disconnects its own access point and connects to the «EPS-Master» access point.

The user, having connected to the access point created by the «EPS-Master», and in the Web-browser (Opera, Chrome, Fire Fox, others) by going to the address «http://192.168.4.1», gets access to the settings - Wi-Fi connections.

In all operating modes, in the event of an alarm (overcurrent, overvoltage above a preset level, or under-voltage below a preset level), the «EPS-Master» and «EPS-Slave» perform emergency load disconnection.

3. INTENDED USE

3.1 Preparation for use

- Unpack the «EPS-Master» and «EPS-Slave» (we recommend to keep the original packaging for the entire warranty period);
- Check the «EPS-Master» and «EPS-Slave» for any damage after transportation, if any, contact the supplier or manufacturer;
- Carefully study the Operation Manual;
- If the «EPS» temperature after transportation or storage differs from the temperature of the environment at which the operation is supposed, then before connecting to the power supply keep the «EPS» under the operating conditions for two hours (since moisture condensation is possible on the internal elements);
- If you have any questions about «EPS» installation, please contact the manufacturer over the telephone number listed at the end of the Operation Manual.

3.2. Connection of the «EPS»

ATTENTION! ALL CONNECTIONS MUST BE PERFORMED WITH THE «EPS» POWERED OFF.

An error during installation work can damage the «EPS» and the devices connected to it.

To ensure reliability of electrical wiring when connecting the «EPS-Master», use flexible (stranded) wires with insulation for a voltage of at least 450 V, the ends of which must be stripped of insulation by 10 - 12 mm and crimped with ferrules. Fastening of wires should exclude mechanical damage, twisting and thinning of wire insulation.

The wire cross-section for connecting the protected equipment must be at least 10 mm².

DO NOT LEAVE BARE WIRE RUNS OUTSTANDING THE «EPS-MASTER» TERMINAL BOARD.

For reliable contact, it is necessary to tighten the screws of the «EPS-Master» terminal block with the force specified in Table 1.

With a decrease in the tightening force, the junction heats up, the terminal block may melt and the wire may catch fire. With an increase in the tightening force, the screw thread of the terminal block may break or the connected wire may be pinched.

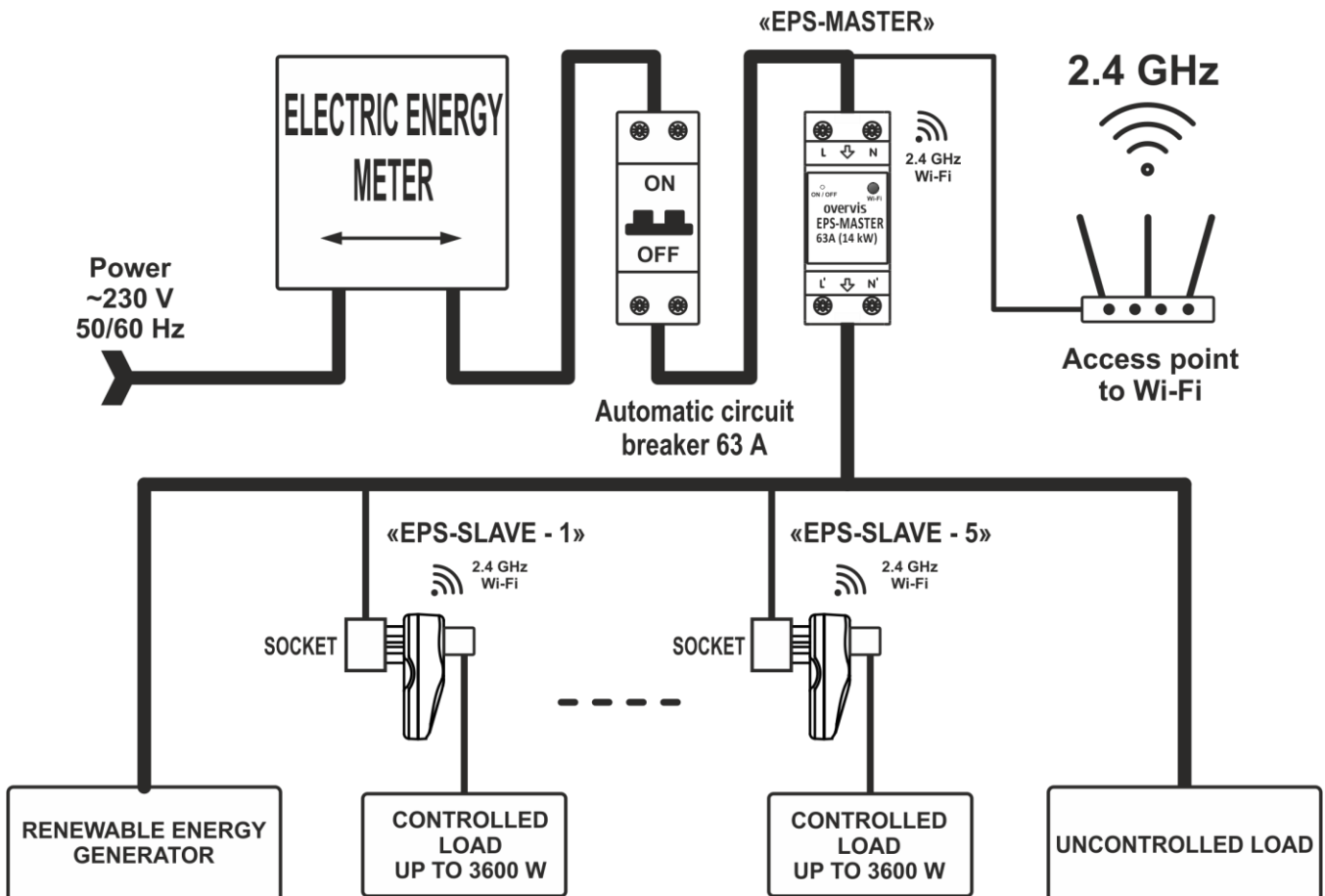

Fig. 3 – «EPS» connection diagram

3.2.1 Switch off the supply voltage with the circuit breaker (Fig. 3).

3.2.2 Connect the «EPS» according to the diagram shown in Figure 3 and check for correct connection.

3.2.3 Switch on the circuit breaker. In this case, the status indicators (Fig. 1, pos. 2 and Fig. 2, pos. 1) will start flashing in blue.

3.2.4 Configure the Wi-Fi connection as described in paragraph 3.4.1.

3.3 «Wi-Fi» button control

The «Wi-Fi» button (Fig. 1, pos. 3 and Fig. 2, pos. 1) is used to make control from the front panel of the device.

When you hold down the «Wi-Fi» button, the status indicator (Fig. 1, pos. 2 and Fig. 2, pos. 1) will change its color, depending on the duration of the button holding - thereby indicating the action being performed.

To confirm the execution of the action, it is necessary to release the «Wi-Fi» button while the status indicator is on.

Table 2 lists all possible actions and colors of the status indicator.

Table 2 - Color of the status indicator when holding the «Wi-Fi» button

Color	Holding time, s	Action to be taken
Purple	1	Button pressing has been detected, no action will be performed
Blue-red (flashing)	5 - 10	Enable Wi-Fi connection setup mode
Purple	10 - 15	Reset settings to factory defaults
---	> 15	No action will be taken

3.4 «EPS» setting

3.4.1 Creating an account at «my.overvis.com»

To link the «EPS» with the «my.overvis.com» cloud service, you need a registered account.

If you already have an account at «my.overvis.com», then creating a new one is not required.

To register a new account, you must:

- Open the site «https://my.overvis.com»;
- Click the link «No account: Register»;
- Fill in the proposed fields with your data (Email, Password, Name, etc.);
- Press the «Save» button. In this case, a letter will be sent to the specified e-mail address with instructions for completing registration;
- Open the received letter and follow the instructions to complete the registration;
- Registration is complete.

ATTENTION! An account with an incomplete registration will be automatically deleted after 25 hours.

3.4.2 Wi-Fi Connection Setup

Wi-Fi Connection Setup is done in 6 st.

Step 1

Press and hold the «Wi-Fi» button on the front panel of the «EPS-Master» (Fig. 1, pos. 3) for 5-8 seconds.

In this case, the status indicator «ON/OFF» (Fig. 1, pos. 2) will start flashing in blue-red - release the button.

«EPS-Master» will create its own Wi-Fi access point named «EPS-Master_xxxxxx», where xxxxxx is a unique device code (see Fig. 4).

Similarly, you need to enter the Wi-Fi connection setup mode on all «EPS-Slave» devices.

Note - to exit the Wi-Fi connection setup mode forcibly, press and hold the «Wi-Fi» button on the «EPS-Master» front panel for 5-6 seconds. Release the button, thereby the status indicator will stop flashing in blue-red, and the «EPS-Master» will return to the normal operation.

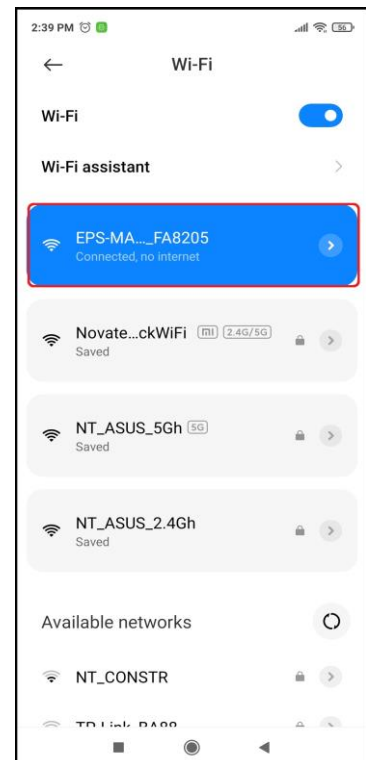

Fig. 4 – Access point in «EPS-Master»

Step 2

By using an electronic device (PC with Wi-Fi, phone, tablet, laptop, etc.), connect to an access point using the following parameters:

- Access point name «EPS-Master_xxxxxx»;
- Security «No».

Launch a Web browser on the electronic device (Chrome, Opera, Fire Fox, etc.).

In the address bar of the browser, enter «http://192.168.4.1» and follow the link entered.

The screen of the electronic device will open «EPS-Master» Web-interface (see Fig. 5).

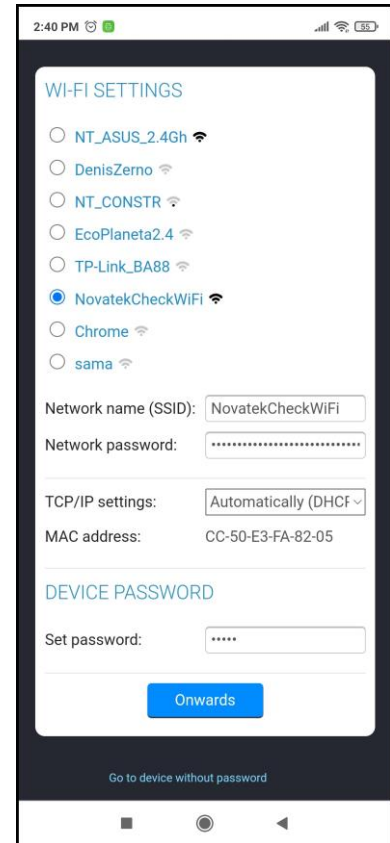

Fig. 5 – Wi-Fi setup

Step 3

Set up a Wi-Fi connection by selecting a home Wi-Fi network from the list and entering a password:

- **Network name** (SSID) - the name of the home Wi-Fi network;
- **Network password** - home Wi-Fi network password;
- **TCP/IP settings** - settings for IP address, subnet mask and gateway address (by default, it is setup automatically);
- **MAC address** - unique address of the device;
- **Device password** - used for remote connection to the device (by default «admin»).

Note - Wi-Fi settings will be transferred to the «ESP-Slave» devices automatically when they are connected.

Press the «Onwards» button - to save the Wi-Fi settings and go to the page for setting the «EPS» operating mode (see Fig. 6).

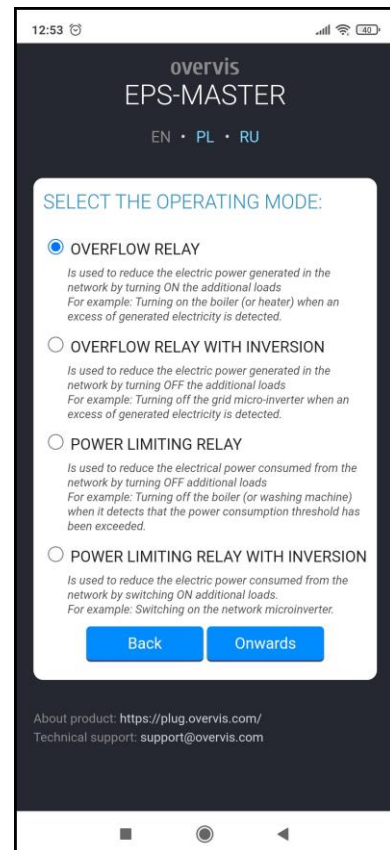

Fig. 6 – Setting up the «EPS» mode of operation

Step 4

Here it is necessary to indicate in which operating mode the «EPS» will be used (description of modes is given in paragraph 2.2).

Note - if you need to change the Wi-Fi settings at the previous step, press the «Back» button.

Press the «Onwards» button to save the «EPS» operating mode and go to the «EPS-Slave» devices connection page (see Fig. 7).

Step 5

The «EPS-Slave» devices found will be displayed in a list on the screen.

If some «EPS-Slave» devices are not in the list, make sure that they are in the Wi-Fi connection setting mode (see paragraph 3.4.2, step 1) and the «ON/OFF» indicator is flashing in the blue-red color.

Note - if it is necessary to change the «EPS» operating mode at the previous step, press the «Back» button.

Make sure that all «EPS-Slave» devices are present in the list, then click the «Onwards» button to set up automatically all the found «EPS-Slave» devices.

Upon completion of settings saving, a message about successful saving of the settings and a link in the form of a green button will appear on the screen of the electronic device (see Fig. 8).

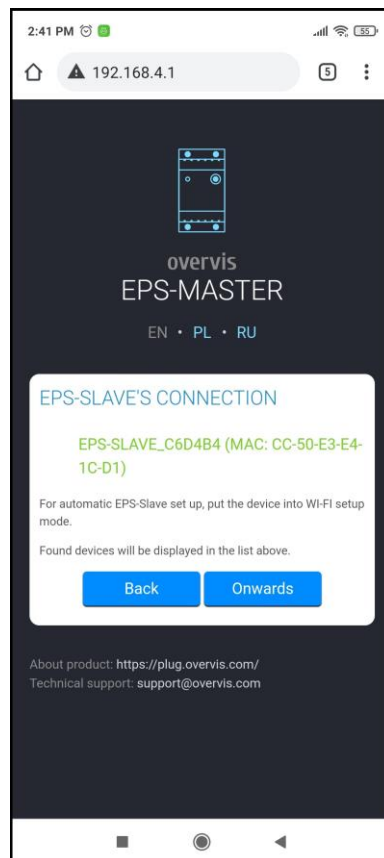

Fig. 7 – List of the «EPS-Slave» found

Step 6

Wait until the «EPS-Master» and all connected «EPS-Slave» are connected to the Wi-Fi network (the status indicator will stop flashing rapidly in blue and blue-red).

Notes:

1 - if the status indicator is constantly flashing in blue, check for presence of a Wi-Fi network and repeat the Wi-Fi connection setup (see paragraph 3.4.2);

2 - if the link does not appear for some time (20 - 30 s), check for connection of the electronic device to the home Wi-Fi network and the availability of the Internet (on some devices, you may need to connect manually to the home Wi-Fi network).

3 - before linking «EPS» to your account, it is strongly recommended that you create or log into your account at «<https://my.overvis.com>» in advance (see paragraph 3.4.1).

Follow the link in the form of a green button at the bottom of the screen (see figure 8) - to link the «EPS» to your account on the cloud service «my.overvis.com».

Otherwise, you will not be able to access the «EPS» from «my.overvis.com».

After clicking on the link, the main interface of the «EPS-Master» will be displayed on the screen of the electronic device (see Fig. 8).

The setup is complete!

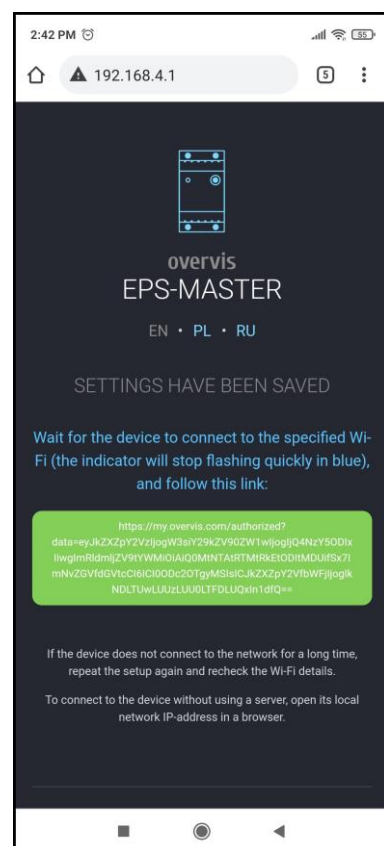

Fig. 8 – Connection to «my.overvis.com»

For the next access to the «EPS», use «my.overvis.com» service.

The access to the service is carried out around the clock 24/7 using the link «<https://my.overvis.com>».

Note - if you need to connect a new «EPS-Slave» device to Wi-Fi, repeat the Wi-Fi connection setup procedure (see paragraph 3.4.2) or set up all the parameters manually by connecting to the access point created by the «EPS-Slave».

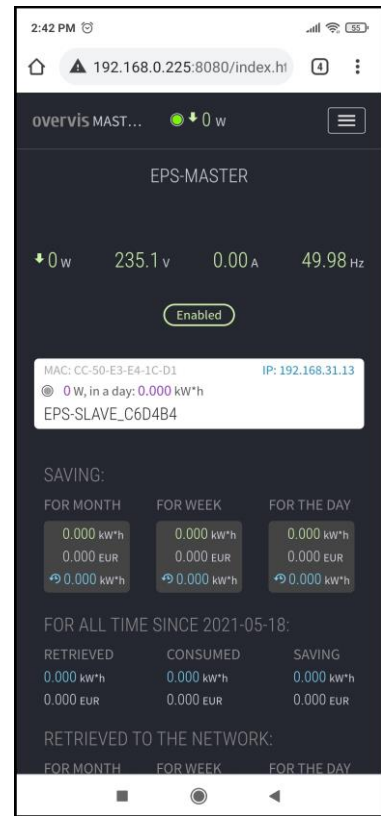

Fig. 9 – Interface with the «EPS-Master»

3.4.3 Connection to the «EPS» via the cloud service «my.overvis.com»

Connection to the «EPS» via the cloud service «my.overvis.com» is possible only after registering on server «https://my.overvis.com» and linking the «EPS» with an account on «my.overvis.com» (see paragraphs 3.4.1, 3.4.2).

Enter the link «https://my.overvis.com» on an electronic device (PC, laptop, mobile phone, tablet, etc.) in the address bar of the Web browser (Chrome, Opera, Fire Fox, etc.), and follow it.

On the screen of the device from which the transition was made, a page for entering credentials appears (see Fig. 10).

Log into your account - using your username and password.

Note - if you do not have a username or a password, use the additional links «No account» or «Forgot your password».

After logging into your account, you must select «EPS-Master» from the following list of devices. In this case, the screen will display the main interface «EPS-Master» (see Fig. 9).

To turn off the «EPS-Master» - you need to click the «Exit» button or just close the page «my.overvis.com».

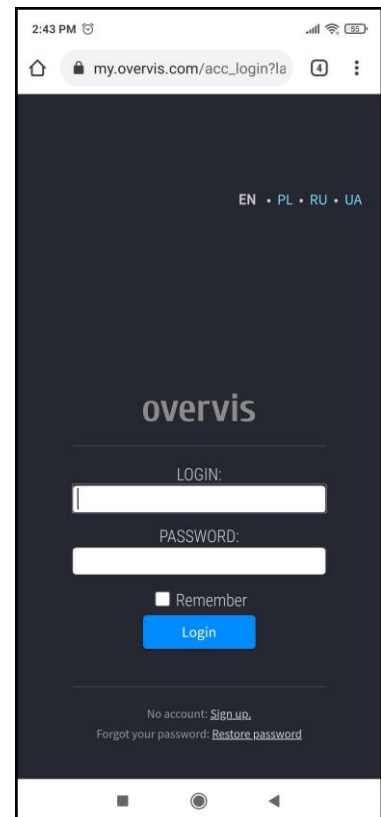

Fig. 10 – Entering the server «my.overvis.com»

3.4.4. Connection to the «EPS» via a local Wi-Fi network

Control and setup via a local Wi-Fi network is possible only after preliminary setup of the Wi-Fi connection (see paragraph 3.4.2).

It is necessary to reserve the IP address for the device by its MAC address in the settings of the router, (see the Operating Manual for the router). Alternatively, when setting up a Wi-Fi connection, set the «Manual» value in the «TCP/IP settings» field and specify the static settings:

- **IP address** - an unoccupied address in your network (example: 192.168.0.105 or 10.0.0.5);
- **Subnet mask** - your subnet mask (example: 255.255.225.0 or 255.0.0.0);
- **Default gateway** - the IP address of your router (example: 192.168.0.1 or 10.0.0.1);
- **DNS1** - primary domain name server (example: 208.67.222.222);
- **DNS2** - secondary domain name server (example: 8.8.8.8).

Enter the link «<http://192.168.0.105>» on an electronic device (PC, laptop, mobile phone, tablet, etc.) in the address bar of the Web-browser (Chrome, Opera, Fire Fox, etc.), and follow it (where 192.168.0.105 is the device's IP address reserved on the router or statically specified).

On the screen of the device from which the transition was made, the password entry page will be displayed (see Fig. 11), you must enter the password (by default «admin») and press the «Enter» button.

If the entered password is correct, after a few seconds the main interface «EPS-Master» will be displayed on the screen (see Fig. 9).

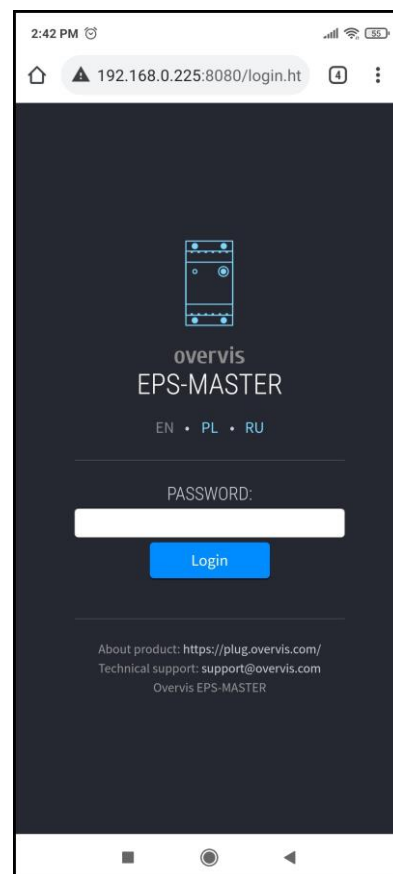

Fig. 11 – Local entry to the «EPS-Master»

3.4.5. Linking «EPS-Slave» to «EPS-Master» and Prioritization

To associate the «EPS-Slave» with «EPS-Master», all devices must be connected to the home Wi-Fi network, and the status indicator must not flash blue rapidly.

Log in to the «EPS-Master» according to paragraph 3.4.3 or 3.4.4.

Open the settings menu (by clicking the button in the upper right corner of the screen), select the «SETTINGS» menu item and scroll through the list of parameters to section «EPS-SLAVE UNITS» (see Fig. 12).

It is possible to connect up to 5 devices to the «EPS-Master», «EPS-Slave», one for each priority, there are five in total:

- Highest;
- High;
- Medium;
- Low;
- Lowest.

Each priority corresponds to the sequence of switching on the load: so «HIGHEST PRIORITY» - will be switched on first, and «LOWEST PRIORITY» – the last.

In the «HIGHEST PRIORITY» group, select the required «EPS-Slave» device from the drop-down list.

Notes:

1 - the «EPS-Slave» device can be identified by the last digits in the name and the MAC address located on the body in the form of a sticker (example: «EPS-SLAVE_5F812A» and «MAC: XXXXXX5F812A»);

2 - if the required «EPS-Slave» device is not listed, make sure that the «EPS-Slave» is powered up and connected to your home Wi-Fi network, or try updating the page with settings.

Click the «More settings» link, and additional settings will become available for the selected «EPS-Slave» device (see Fig. 13):

- In the «**On-threshold**» field - specify the power value, upon reaching which the load will be switched on by this «EPS-Slave» device;
- In the «**On-delay**» field, specify the delay time before switching on the load;
- In the field «**Off-threshold**» - specify the power value, upon reaching which the load will be disconnected for the given «EPS-Slave» device;
- In the «**Off-delay**» field, specify the delay time before switching off the load.

Note - for on and off thresholds, a value less than zero corresponds to the threshold for generated power, and a value greater than zero corresponds to the threshold for consumed power.

If there are more than one «EPS-Slave» devices to be connected, set up the rest of the priorities.

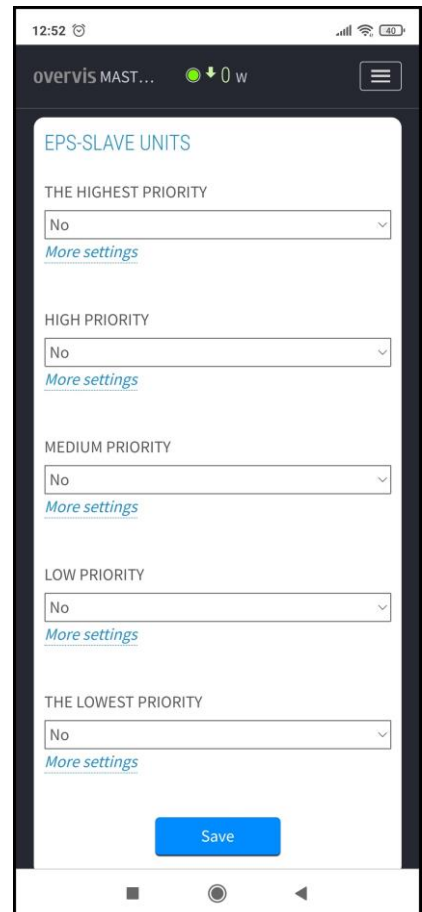

Fig. 12 – Setting up the «EPS-Master»

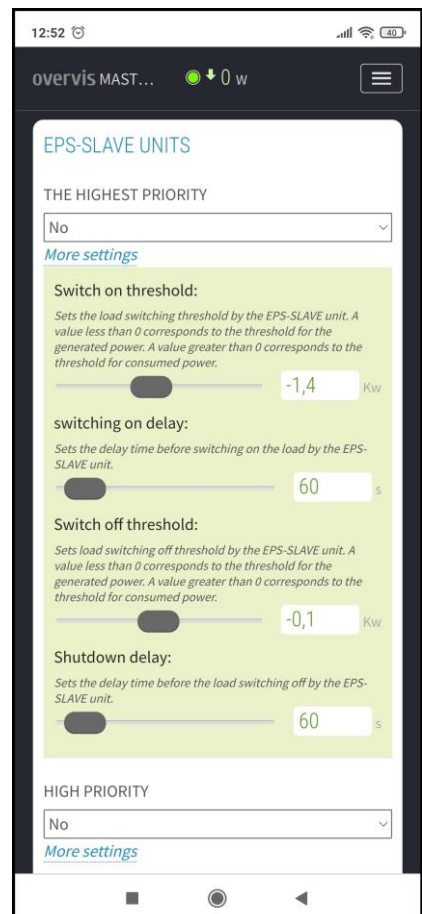

Fig. 13 – Threshold setting up

3.5 Use of «EPS»

When describing the «EPS» operation, the example is considered with two connected «EPS-Slave» devices, and the settings set by the manufacturer.

Note - *thresholds and time delays can be changed by the user in the «EPS-Master» and «EPS-Slave» settings.*

3.5.1 Operation of the «EPS-Master»

After connection of the «EPS-Master» to the mains, a time delay of 5 s takes place, then, if the mains voltage is within the permissible limits, the «EPS-Master» switches on the load.

The «EPS-Master» makes also connection to the home Wi-Fi network (to control «EPS-Slave» devices, to synchronize the time with the NTP server and to have access to the «my.overvis.com» cloud service).

The «EPS-Master» constantly controls the value of the mains voltage, and after switching on the load - the amount of current consumed by the load. If one of them goes beyond the set limits, the «EPS-Master» performs an emergency load tripping.

After establishing connection with the «EPS-Slave» devices, the «EPS-Master» adds them to the list of load control devices (the position in the list corresponds to the priority set by the user when linking the «EPS-Slave» with the «EPS-Master» (see paragraph 3.4.5)).

If within 60 seconds the «EPS-Master» has not received data from the «EPS-Slave» - the connection is considered lost and the «EPS-Slave» is excluded from the load control list, and when the connection is restored, it will be added again.

Every 5 minutes the «EPS-Master» saves the log-book (voltage, current, power, etc.) in the non-volatile memory.

3.5.2 Load protection depending on the mains voltage

During operation, the «EPS-Master» and «EPS-Slave» constantly measure the value of the mains voltage.

When the voltage rises above the threshold of 255 V (Upper off-threshold), the load will be tripped off in 0.5 s (Off-delay at the upper threshold).

When the voltage rises above the 285 V threshold («Upper off- threshold» + 30 V), the load will be tripped off with a fixed time delay of 0.2 s.

When the voltage rises above 300 ± 10 V, the load will be tripped off with a fixed time delay of 0.05 s.

After load tripping off, if the mains voltage has dropped below 250 V («Upper off- threshold» 255 V minus 5 V hysteresis), it will return to normal operation after AR time (5 s).

When the voltage drops below the threshold of 160 V (Lower off-threshold), the load will be tripped off in 12.0 s (Off-delay at the lower threshold).

When the voltage drops below 145 V, the load will be tripped off with a fixed time delay of 0.25 s.

After load tripping off, if the mains voltage rises above 195 V («Lower off-threshold» 190 V plus hysteresis 5 V), the return to normal operation will take place after the AR time (5 s).

Operation of the «EPS-Master» and «EPS-Slave» in the failure mode is described in paragraph 3.5.4 (Load tripping-off due to a failure).

3.5.3 Load overcurrent protection

During operation, the «EPS-Master» and «EPS-Slave» constantly measure the current consumed by the load.

When the load current rises above the maximum value by 1 A (64 A - for the «EPS-Master» and 17 A - for the «EPS-Slave»), the load will be tripped off in a fixed time of 5 s.

After load tripping-off, it will return to normal operation after a fixed time of 60 s.

Operation of the «EPS-Master» and «EPS-Slave» in the failure mode is described in paragraph 3.5.4 (Load tripping-off due to a failure).

3.5.4. Load tripping-off due to a failure

In the event of a failure (overvoltage, under-voltage, overcurrent, etc.), the load is tripped off, and the status indicator (Fig. 1, pos. 2 or Fig. 2, pos. 1) turns red.

When the alarm disappears, the status indicator starts flashing in red, indicating that the re-closure time is in progress, after which the load will be automatically switched on.

If during the counting of the reclosing time a failure occurs again, the counting of the reclosing time will be stopped, and the status indicator will turn red.

3.5.5. Operation in the overflow relay mode (turning on the boiler or electric heater when an excess of generated electric energy is detected)

In this mode, initially, on all «EPS-Slave» devices, the load is off, and the sequence of switching on the load is as follows:

- The load on the «EPS-Slave» with the highest priority is switched on first;
- The load on the «EPS-Slave» with the lowest priority is switched on last.

The «EPS-Master» constantly measures the values of the **generated** and **consumed** power and, depending on the result of measurement, controls the connected «EPS-Slave» according to the following algorithm, shown in Fig. 14:

- if the value of the **generated** power becomes greater than or equal to the activation threshold of the first «EPS-Slave» (-1.3 kW):
 - 60 s time starts counting (parameter «On-delay», time T1 – Fig. 14);
 - if the time countdown is over, the load will be switched on at the first «EPS-Slave» (time T2).
- if the value of the **generated** power continues to be higher than the threshold for switching on the second «EPS-Slave» (-1.3 kW):
 - 60 s time starts counting (parameter «On-delay», time T2 or T4);
 - if during the time countdown the value of the **generated** power becomes less than the activation threshold of the second «EPS-Slave» - the timing will stop (time T3);
 - if the time countdown is over, the load will be switched on at the second «EPS-Slave» (time T5).
- if the value of the **consumed** power becomes greater than the threshold for switching off the second «EPS-Slave» (0.3 kW):
 - 60 s time starts counting (parameter «Off-delay», time T6);
 - if the time countdown is over, the load will be disconnected at the second «EPS-Slave» (time T7).
- if the value of the **consumed** power continues to be higher than the cut-off threshold of the first «EPS-Slave» (0.3 kW):
 - 60 s time starts counting (parameter «Off-delay», time T7 or T9);
 - if during the time countdown the value of the **consumed** power has become less than the cutoff threshold of the first «EPS-Slave» - the countdown stops (time T8);
 - if the time countdown is over, the load will be disconnected at the first «EPS-Slave» (time T10).

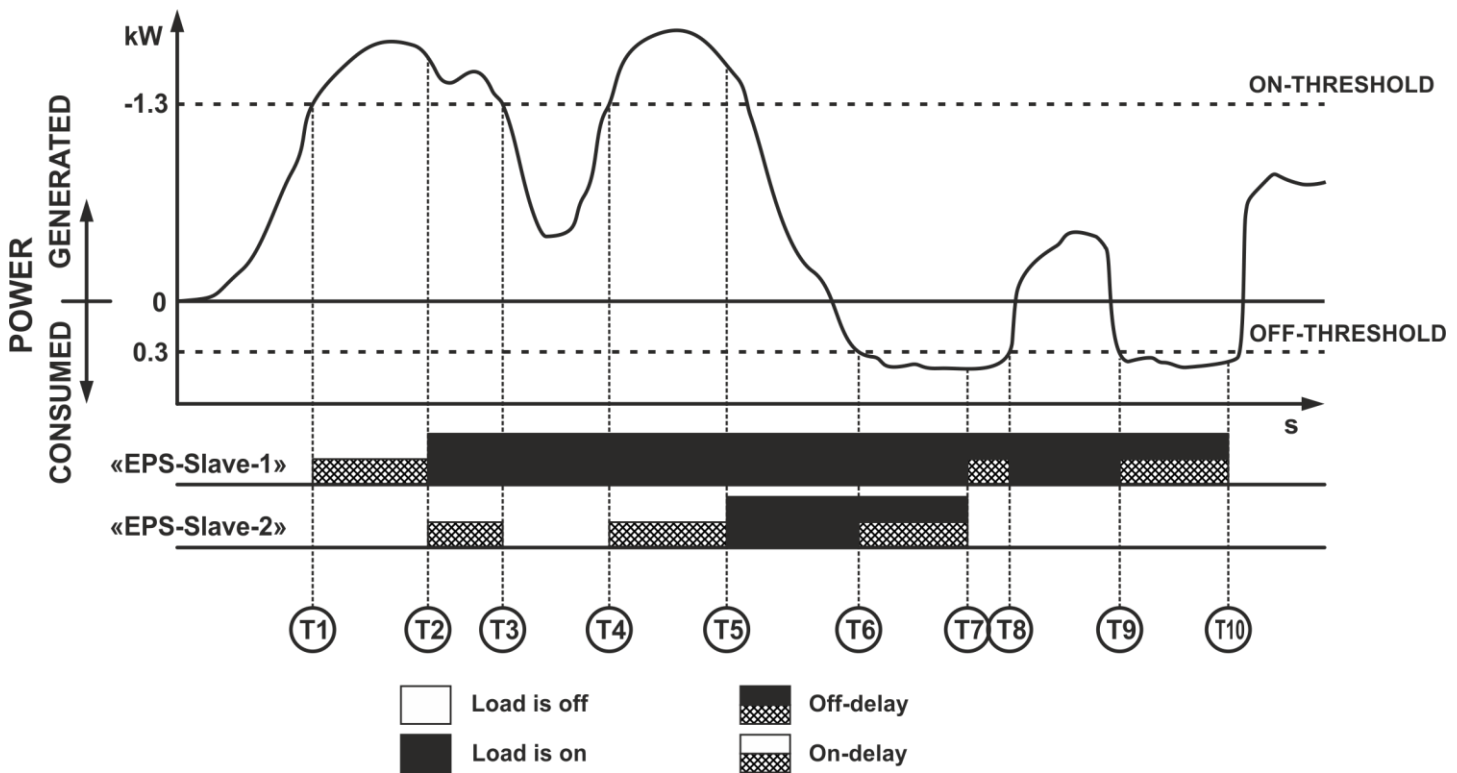

Fig. 14 – Operation of the overflow relay mode

3.5.6 Operation in the overflow relay mode with inversion (switching off the network micro-inverter when an excess of generated power is detected)

In this mode, initially additional power sources on all «EPS-Slave» devices are switched on, and the sequence of their shutdown is as follows:

- The first to be turned off is the additional power source on the «EPS-Slave» with the lowest priority;
- The last one to be turned off is the additional power supply on the «EPS-Slave» with the highest priority.

The «EPS-Master» constantly measures the values of the **generated** and **consumed** power and, depending on the result of measurement, controls the connected «EPS-Slave» according to the following algorithm, shown in Fig. 15:

- if the value of the **generated** power becomes greater or equal to the off-threshold of the second «EPS-Slave» (-0.7 kW):
 - 60 s time starts counting (parameter «Off-delay», time T1 or T8 – Fig. 15);
 - if during the time countdown the value of the **generated** power becomes less than the off-threshold, then the timing stops (time T9).
 - if the time countdown is over, the additional power source will be switched off at the second «EPS-Slave» (time T2).
- if the value of the **generated** power continues to be higher than the cut-off threshold of the first «EPS-Slave» (-0.7 kW):
 - 60 s time starts counting (parameter «Off- delay», time T2);
 - if the time countdown is over, the additional power source will be switched off at the first «EPS-Slave» (time T3).
- if the value of the **consumed** power becomes more than the on-threshold of the first «EPS-Slave» (1.5 kW);
 - 60 s time starts counting (parameter «On-delay», time T4);
 - if the is over, an additional power source will be switched on at the first «EPS-Slave» (time T5).
- if the value of the **consumed** power becomes more than the threshold for switching on the second «EPS-Slave» (1.5 kW):
 - 60 s time starts counting (parameter «On-delay», time T6);
 - if the time countdown is over, an additional power source is switched on at the second «EPS-Slave» (time T7).

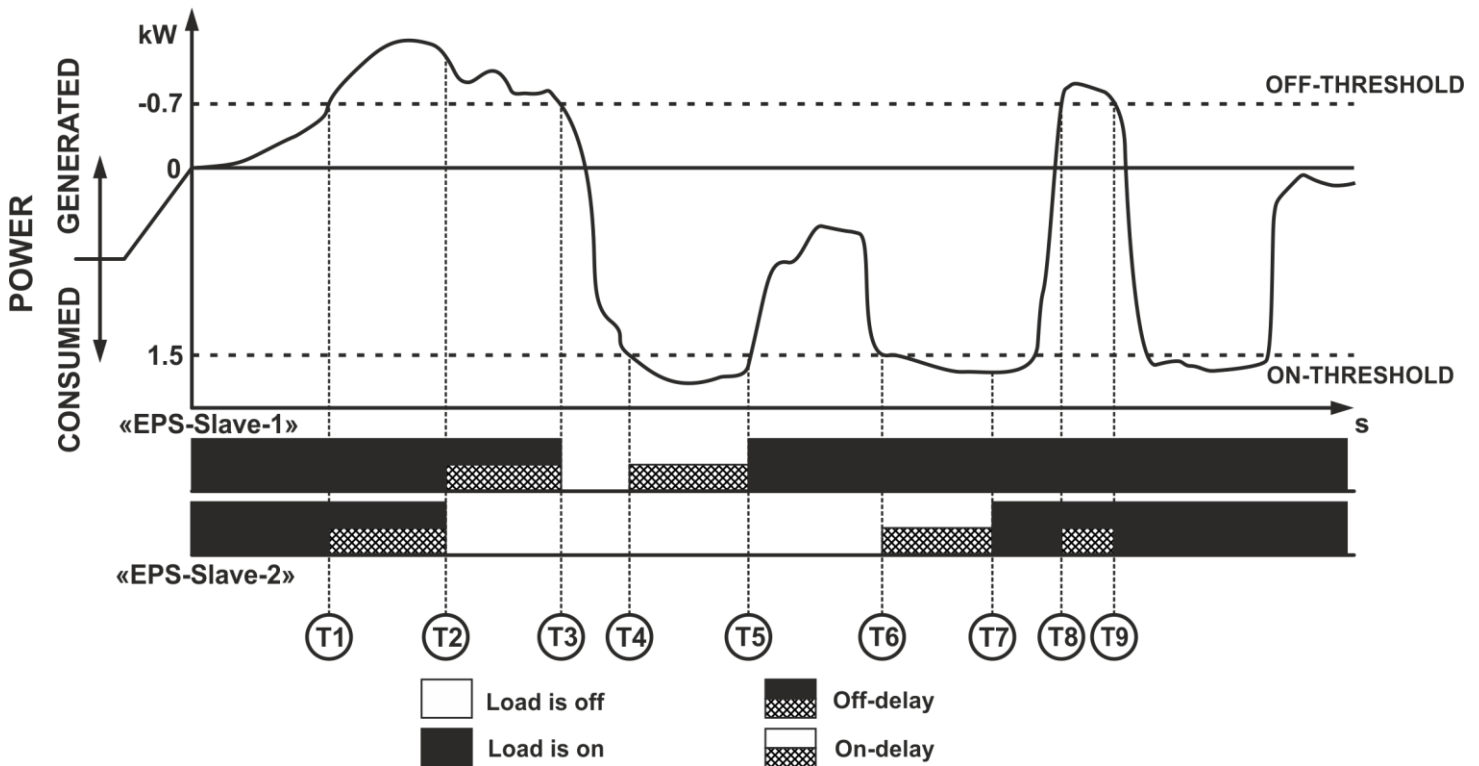

Fig. 15 – Operation in the overflow relay mode with inversion

3.5.7 Operation in the power limiting relay mode (switching off the boiler or washing machine when the power consumption threshold is exceeded)

In this mode, the load is initially switched on in all «EPS-Slave» devices, and the sequence of load disconnections is as follows:

- The load on the «EPS-Slave» with the lowest priority is disconnected first;
- The load on the «EPS-Slave» with the highest priority is disconnected last.

The «EPS-Master» constantly measures the values of the **generated** and **consumed** power and, depending on the result of measurement, controls the connected «EPS-Slave» according to the following algorithm, shown in Fig. 16:

- if the value of the **consumed** power becomes greater or equal to the off-threshold of the second «EPS-Slave» (3.0 kW):
 - 60 s time starts counting (parameter «Off-delay», time T1 or T7 – Fig. 16);

- if the time countdown is over, the load will be switched off at the second «EPS-Slave» (time T2 or T8).
- if the value of the **consumed** power becomes greater than the off-threshold of the first «EPS-Slave» (3.0 kW):
 - 60 s time starts counting (parameter «Off-delay», time T3 or T8);
 - if during the time countdown the value of the **consumed** power becomes less than the off-threshold, then the countdown will stop (time T4);
 - if the time countdown is over, the load will be switched off at the first «EPS-Slave» (time T9).
- if the value of the **consumed** power becomes less than the on-threshold of the second «EPS-Slave» (0.5 kW):
 - 60 s time starts counting (parameter «On-delay», time T5);
 - if the time countdown is over, the load will be switched on at the second «EPS-Slave» (time T6).

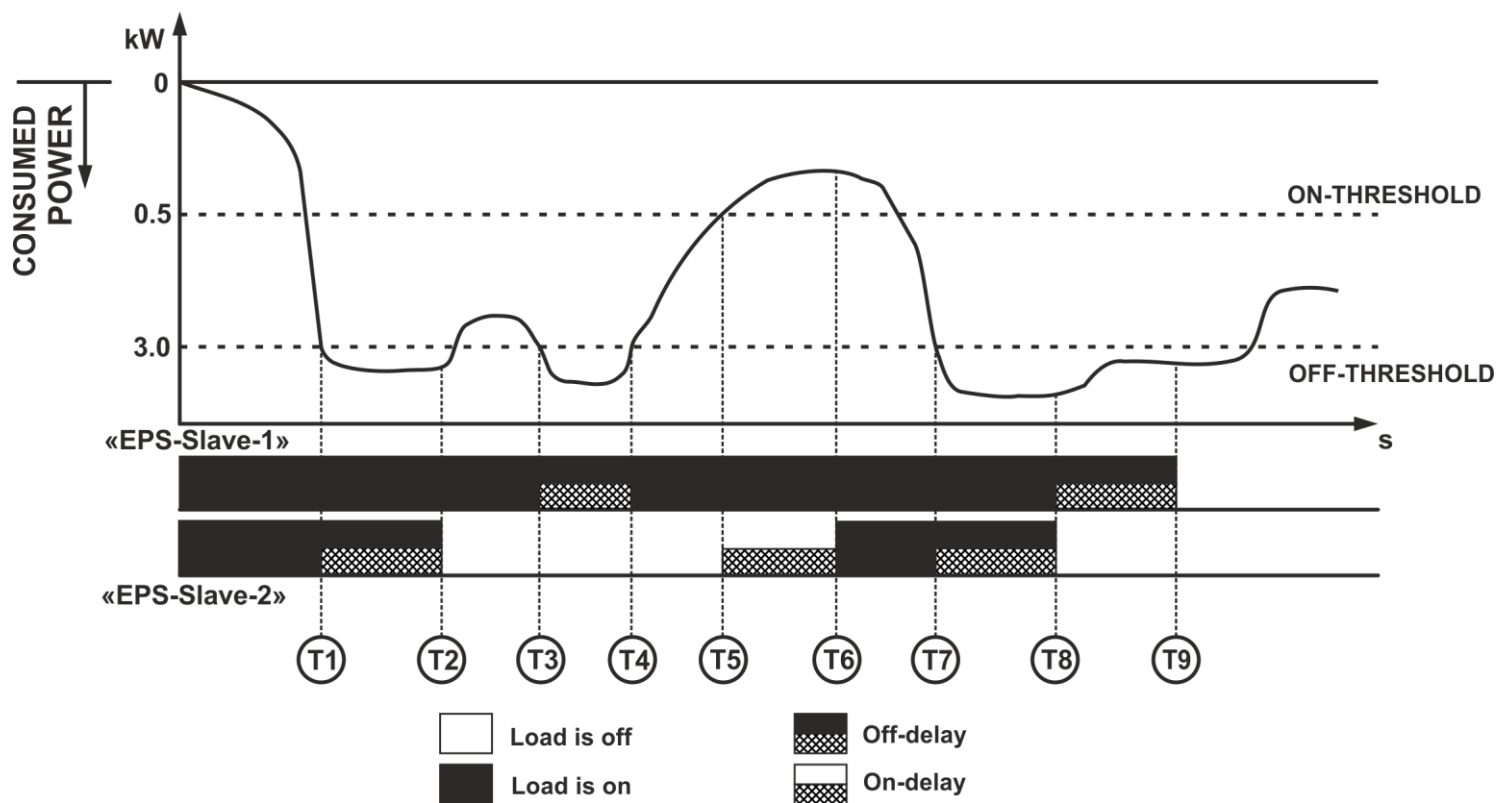

Fig. 16 – Operation in the power limiting relay mode

3.5.8 Operation in the power limiting relay mode with inversion (switching on the network micro-inverter)

In this mode, initially the additional power sources on all «EPS-Slave» devices are turned off, and the sequence of their activation is as follows:

- The first to be switched on is an additional power source on the «EPS-Slave» with the highest priority;
- The last one to be switched on is an additional power source on the «EPS-Slave» with the lowest priority.

The «EPS-Master» constantly measures the values of the **generated** and **consumed** power and, depending on the result of measurement, controls the connected «EPS-Slave» according to the following algorithm, shown in Fig. 16:

- if the value of the **consumed** power becomes greater or equal to the on-threshold of the first «EPS-Slave» (1.1 kW):
 - 60 s time starts counting (parameter «On-delay», time T1 or T8 – Fig. 17);
 - if the time countdown is over, an additional power source will be switched on on the first «EPS-Slave» (time T2 or T9);
- if the value of the **consumed** power becomes greater than the on-threshold of the second «EPS-Slave» (1.1 kW):
 - 60 s time starts counting (parameter «On-delay», time T3 or T9),
 - if the time countdown is over, an additional power source will be switched on on the second «EPS-Slave» (time T4 or T10);

- if the value of the **consumed** power becomes less than the **off-threshold** of the second «EPS-Slave» (0.2 kW):
 - 60 s time starts counting (parameter «Off-delay», time T5);
 - if the time countdown is over, an additional power source will be switched off on the second «EPS-Slave» (time T6).
- if the value of the **consumed** power remains less than the off-threshold of the first «EPS-Slave» (0.2 kW):
 - 60 s time starts counting (parameter «Off-delay», time T6),
 - if the time countdown is over, an additional power source will be switched off on the first «EPS-Slave» (time T7).

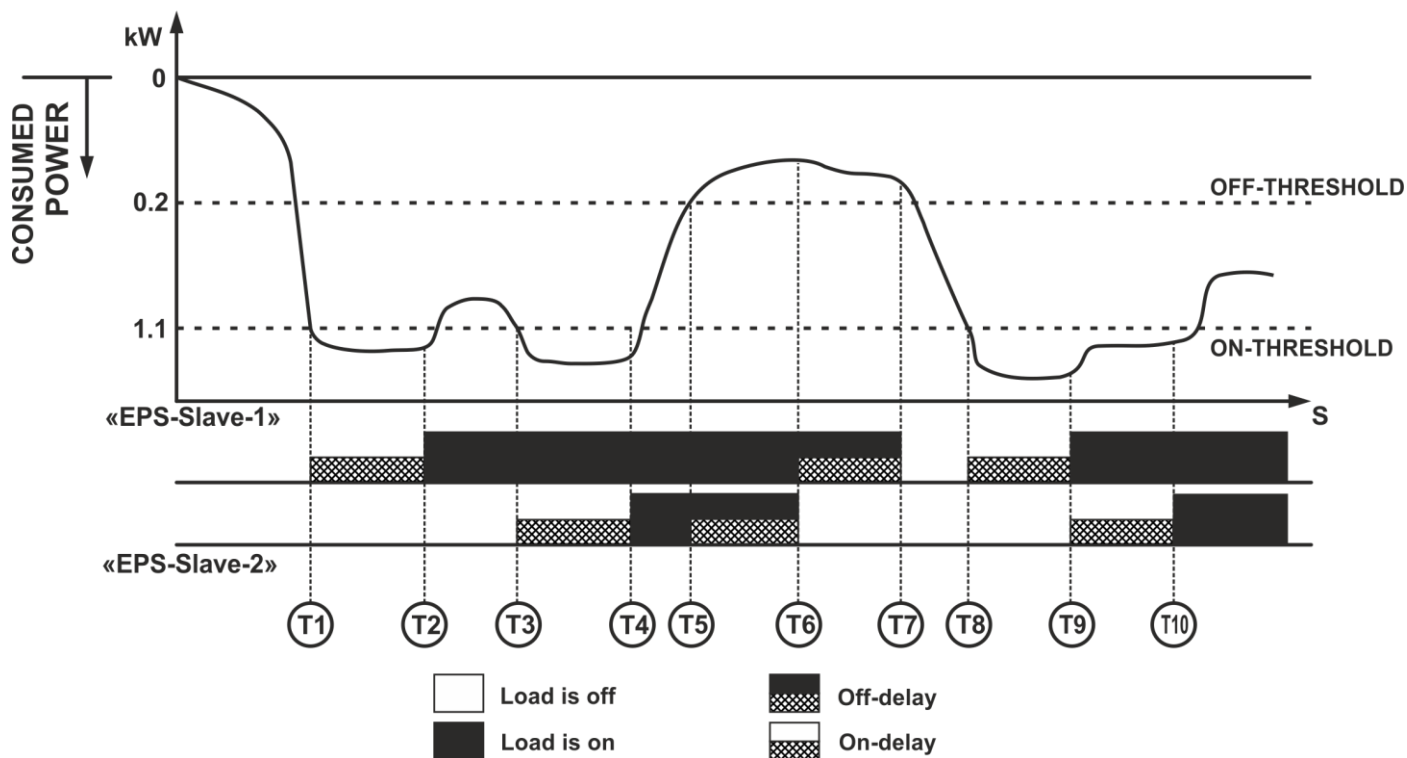

Fig. 17 – Operation in the power limiting relay mode with inversion

3.5.9 Operation of the «EPS-Slave»

After «EPS-Slave» connection to the mains, a time delay of 5 s takes place and a connection to the home Wi-Fi network is made (to receive control commands from the «EPS-Master», to synchronize the time and the current operating mode, as well as to have an access to the cloud service «my.overvis.com»).

The «EPS-Slave» constantly controls the value of the mains voltage, and after switching on the load - the value of the current consumed by the load. If one of them goes beyond the set limits, the «EPS-Slave» performs an emergency power cutoff.

If the «EPS-Master» sends command «Switch on the load», the «EPS-Slave» switches on the load, provided that there is no voltage failure.

If the «EPS-Master» sends a command «Switch off the load», the «EPS-Slave» trips off the load, followed by a time delay of 5 s (to avoid frequent switching on of the load).

If within 60 seconds the «EPS-Master» has not initiated data exchange with the «EPS-Slave», the connection is considered lost and the load:

- will be tripped off - when operating in the flow relay mode and power limiting relay with inversion;
- will be tripped on - when operating in the flow relay mode with inversion and power limiting relay.

The «EPS-Slave» sends its status information to the «EPS-Master» upon request.

Every 5 minutes the «EPS-Slave» saves the log (voltage, current, power, etc.) in the non-volatile memory.

3.5.10 Resetting to factory settings of the «EPS-Master» or «EPS-Slave»

Press and hold the «Wi-Fi» button on the front panel of the device for 12 seconds.

After 12 seconds, the status indicator will turn purple, release the «Wi-Fi» button.

When the factory reset is complete, the status indicator will turn purple and the device will automatically reboot.

The device has been reset to the factory settings and is ready for use.

3.5.11 Data exchange between the «EPS-Master» and «EPS-Slave»

Data exchange between «EPS-Master» and «EPS-Slave» devices is carried out via the UDP protocol.

To search for «EPS-Slave» devices, the «EPS-Master» uses UDP broadcast to port «32500».

To control «EPS-Slave» devices, the «EPS-Master» uses addressable UDP sending to port «32500».

The «EPS-Slave» devices send data to the «EPS-Master» using addressable UDP sending to port «32501».

Note - Make sure for «EPS» correct work, that the router settings do not prohibit transmission of UDP broadcast packets, and also do not prohibit the use of ports «32500» and «32501».

3.5.12 Data exchange between the «EPS» and «my.overvis.com» service

The data exchange between the «EPS» and «my.overvis.com» service is carried out via a TCP connection to the address «http://my.overvis.com» and port «20504».

Note - Make sure for «EPS» correct work, that the router settings do not prohibit outgoing TCP connection to port «20504».

All data between the «EPS» and «my.overvis.com» is received and transmitted using encryption.

4 MAINTENANCE

4.1 Safety precautions



DURING MAINTENANCE, DISCONNECT THE «EPS» AND EQUIPMENT CONNECTED TO IT FROM THE SUPPLYING MAINS.

4.2 Recommended frequency of maintenance is **every six months.**

4.3 Maintenance Procedure:

1) check visually for absence of carbon deposits on the «EPS-Slave» plug, if found, remove carbon deposits;

2) check visually the integrity of the «EPS-Master» and «EPS-Slave» housings, if cracks and chips are found, take them out of service and send them for repair;

3) if necessary, wipe the «EPS» devices housings with a cloth.

Do not use abrasives and solvents for cleaning.

5. SERVICE LIFE AND MANUFACTURER WARRANTY

5.1 The lifetime of the «EPS» is 10 years. Upon expiration of the service life, contact the manufacturer.

5.2 Shelf life is 3 years.

5.3 Warranty period of the «EPS» operation is 3 years from the date of sale.

During the warranty period of operation (in the case of failure of the «EPS») the manufacturer is responsible for free repair of the devices «EPS».

ATTENTION! IF THE «EPS» HAS BEEN OPERATED WITH THE VIOLATION OF THE REQUIREMENTS OF THIS USER MANUAL, THE USER WILL LOSE THE RIGHT TO WARRANTY MAINTENANCE.

5.4 Warranty service is performed at the place of purchase or by the manufacturer of «EPS».

5.5 Post-warranty service of the «EPS» is performed by the manufacturer at current rates.

5.6 Before sending for repair, the «EPS» should be packed in the original or other packing excluding mechanical damage.

6 TRANSPORTATION AND STORAGE

The «EPS» in the original package is permitted to be transported and stored at the temperature from minus 45 to +60 °C and relative humidity of no more than 80 %.

7 ACCEPTANCE CERTIFICATE

The «EPS» has been manufactured and accepted in accordance with the requirements of valid technical documentation and classified as fit for operation.

Head of QCD

Date of manufacture

Seal

Appendix A (reference)

This appendix depicts WEB interface with the «EPS-Master» and its adjustable parameters (see Table A1).

A1. User authorization

After opening the WEB-interface with the «EPS-Master» in the browser of the PC (or any other device with the installed browser), the user authorization page will be displayed.

In order to have an access to the «EPS-Master», you need to enter your password («admin» by default), as shown in Fig. A1.

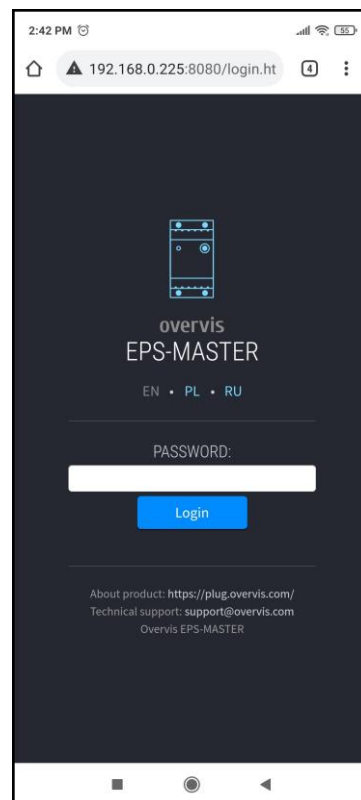



Fig. A1 – Authorization of the user

A2. Status

After successful authorization, the status page will be displayed (see Fig. A2), which displays the current state information of the «EPS-Master».

At the top of the screen, the name of the device «overvis MASTER», the current power consumption by the load «0 W», direction of power and the button «» for opening the main menu are displayed.

In the middle of the screen there are readings of the parameters of the network to be measured (current and power of the load, voltage and frequency of the network).

The state of the load relay («On») and the list of connected «EPS-Slave» devices are located below.

At the bottom of the screen, there are various counters of saved/consumed electric energy and the amount of saved/spent funds.

Counter appearance:



- reading for the current period
- cost for the current period
- reading for the previous period

Note - the reading for the current period changes its color from green to red in case when the value of the current period exceeds the value of the previous period.

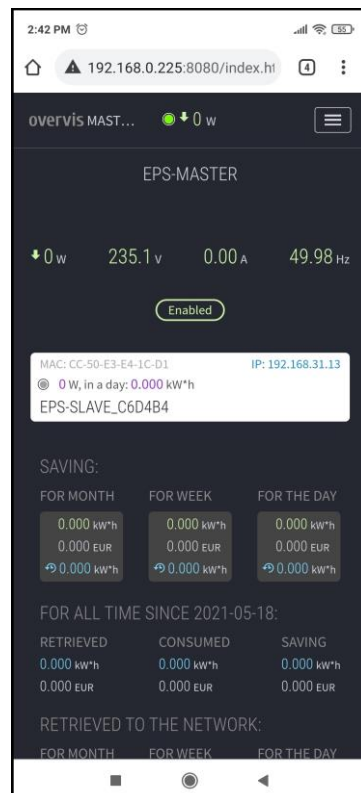

Fig. A2 – The status of the «EPS-Master»

SAVINGS - meters of the generated electric power consumed by all «EPS-Slave» devices connected for the last day, week and month (Indicator of your savings).

RETRIEVED TO THE NETWORK - meters of the generated electric power delivered to the network for the last day, week and month.

CONSUMED FROM THE NETWORK - meters of electric power consumed from the network for the last day, week and month.

FOR ALL TIME SINCE – meters of electric power (saved, given and consumed) for the entire time, starting from the moment of reset.

A3. Main menu

Pressing the «  » button will display the «EPS-Master» main menu, as shown in Fig. A3.

To close the menu, press the «  » button again.

«STATE» - the current state.

«PROTECTION» - settings of protective functions.

«LOG» - viewing the logbook.

«SETTINGS» - basic settings.

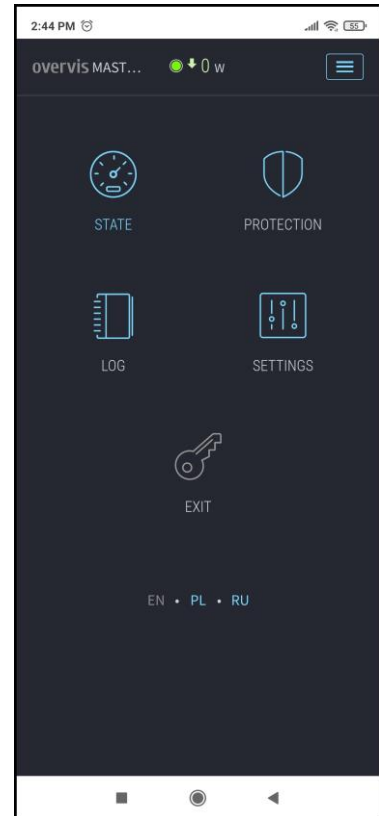

Fig. A3 – Main menu of the «EPS-Master»

A4. Protection

It opens after navigating to a menu item «PROTECTION» (Fig. A4).

This menu item contains settings for voltage protection functions;

- **Upper threshold** – the maximum voltage value, upon reaching which the load will be disconnected;
- **Lower threshold** - the minimum voltage value, upon reaching which the load will be disconnected;
- **Re-closure delay** - delay before reclosing the load after a failure;
- **Save** – to save settings.

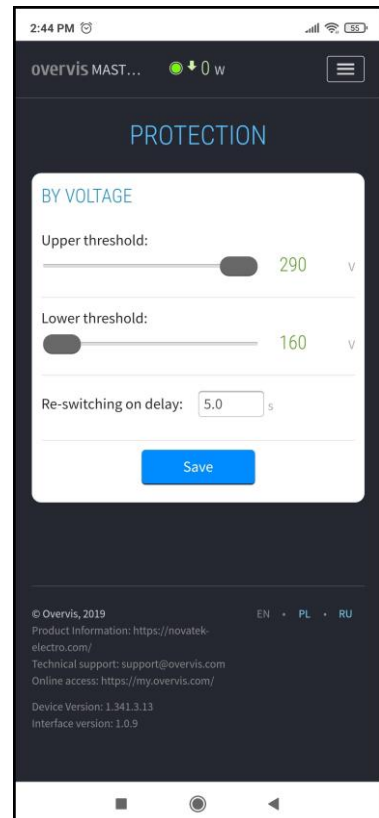

Fig. A4 - Voltage protection

A5. Settings

Opens after navigating to a menu item «SETTINGS»

(Fig. A5).

This menu item contains the basic «EPS-Master» settings, divided into groups:

- Access to the device;
- Electricity cost;
- EPS-Slave units;
- Wi-Fi;
- Date and time;
- Cloud Overvis;
- Additionally.

ACCESS TO THE DEVICE

- **Device Name** – name of the device;
- **Password** – gives a password of access to the «EPS-Master» via the Web-interface;
- **Save** – to save settings of the group

ELECTRICITY COST

- **Consumption cost of 1 kWh** - sets the cost of consumed electric power per 1 kWh;
- **Generation cost of 1 kWh** - sets the cost of generated electric power per 1 kWh;
- **Currency** - sets the currency in which the cost of electric power is calculated;
- **Save** – to save group settings

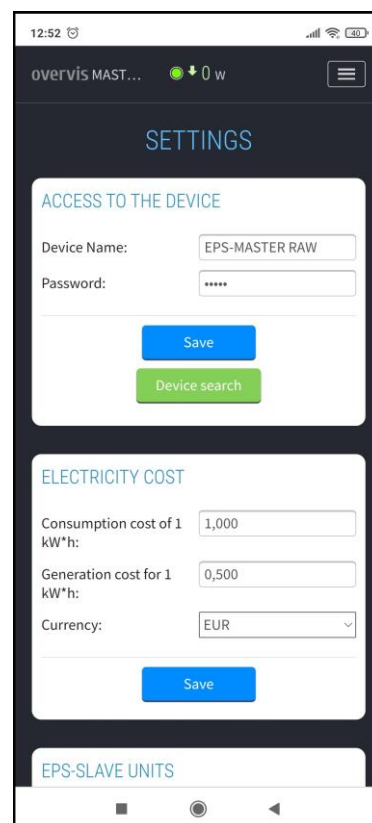

Fig. A5 – basic settings of the «EPS-Master»

EPS-SLAVE UNITS

- **On-delay** - delay time before switching on the load on the «EPS-Slave»;
- **Off-delay** - delay time before disconnection of the load on the «EPS-Slave»;
- **On-threshold** - power threshold for switching on the «EPS-Slave»;
- **Shutdown threshold** - power threshold for «EPS-Slave» shutdown;
- **Save** - save group settings.

Wi-Fi

- **Network name (SSID)** - the name of the Wi-Fi network to which the «EPS-Master» is connected;
- **Password of the network** - password of the Wi-Fi network to which the «EPS-Master» is connected;
- **Enable automatic Wi-Fi restart every 8 hours**;
- **TCP/IP settings** - TCP/IP settings mode (manual or automatic DHCP);
- **IP address** - setting the IP address;
- **Subnet mask** - setting the subnet mask;
- **Default gateway** - setting the address of the default gateway;
- **DNS1** - main domain name server;
- **DNS2** - additional domain name server;
- **MAC address** - unique MAC address of the «EPS-Master»;
- **IP address** - current IP address of the «EPS-Master»;
- **Save** - save the group settings.

DATE AND TIME

- **Time on device** - current date and time on the «EPS-Master»;
- **Time zone** - current time zone on the «EPS-Master»;
- **Enable automatic daylight saving time** - a parameter that allows you to enable or disable the «EPS-Master» to automatically change to daylight saving time and back;
- **Time correction** - clock rate correction on the «EPS-Master», set in seconds per day;
- **Enable time synchronization** - an option that allows you to enable or disable the «EPS-Master» to synchronize the time with the NTP time server;
- **NTP server address** - NTP time server address;
- **Port** - the port for connecting to the time server;
- **Save** - save the group settings;
- **Synchronize with server** – a forced start of time synchronization between the time server and «EPS-Master»;

- **Synchronize with PC** - start time synchronization between PC and «EPS-Master».

OVERVIS CLOUD

- **Enable remote access via the cloud** - whether the «EPS-Master» connection to the Overvis cloud is allowed or denied;
- **Server address** - sets the address of the Overvis cloud;
- **Port** - connection port;
- **Status** - service information about the status of connection to the Overvis cloud;
- **Save** - save group settings.

ADDITIONALLY

- **Indication brightness** - sets the brightness of the device indication glow;
- **Save** - save group settings.

Table A1 - Adjustable parameters of the «EPS-Master»

Name	Range		Value after reset
	from	to	
Network name (SSID)	32 ASCII symbols		empty
Network password	64 ASCII symbols		empty
TCP/IP settings	Manually/automatically		automatically
IP address	0.0.0.0	255.255.255.255	192.168.0.105
Subnet mask	0.0.0.0	255.255.255.255	255.255.255.0
Default gateway	0.0.0.0	255.255.255.255	192.168.0.1
DNS1	0.0.0.0	255.255.255.255	208.67.222.222
DNS2	0.0.0.0	255.255.255.255	8.8.8.8
Voltage protection			
Upper threshold, V	240	290	255
Lower threshold, V	160	230	160
Delay of re-closure, s	0.5	600.0	5.0
Access to the device			
Name of the device	32 ASCII symbols		«EPS-Master_XXXXXX»
Web access password	32 ASCII symbols		«admin»
Electricity cost			
Cost of 1kWh consumption	0.001	9999.9999	1.000
Cost of 1kWh generation	0.001	9999.9999	0.500
Currency	BYR, BGN, CZK, CHF, EUR, GBP, INR, KZT, LVL, LTL, MDL, PLN, PRB, RUB, RON, SEK, UAH, USD		EUR
Date and time			
Greenwich Mean Time (GMT)	UTC-12:00	UTC+13:00	UTC+0:00
Time correction, s	-9.9	+9.9	+0.0
Automatic changeover to summer time and back	No/Yes		No
Time synchronization	Off/On		On
NTP server address	32 ASCII symbols		«time.windows.com»
Port of connection	1	65535	123
«my.overvis.com» cloud			
Work authorization	Off/On		On
Server address	32 ASCII symbols		«my.overvis.com»
Port of connection	1	65535	20504
Executive units			
On-delay, s	5	1200	60
Off-delay, s	5	1200	60
On-threshold, kW	-15.2	15.2	0.3
Off-threshold, kW	-15.2	15.2	-1.3
Additionally			
Indication brightness	1	15	12

Appendix B (informative)

This appendix depicts WEB-interface with the «EPS-Slave» and its adjustable parameters (see Table B1).

B1. User authorization

After opening the WEB-interface with the «EPS-Slave» in the browser of the PC (or any other device with the installed browser), the user authorization page will be displayed.

In order to have an access to the «EPS-Slave», you need to enter your password («admin» by default), as shown in Fig. B1.

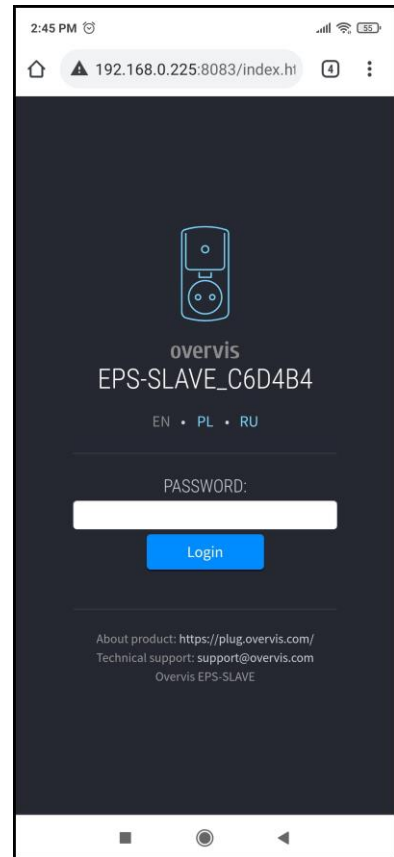



Fig.B1 – User authorization

B2. Status

After successful authorization, the status page will be displayed (see Fig. B2), which displays the current state information of the «EPS-Slave».

At the top of the screen, the name of the device «overvis Slave», the current power consumption by the load «0 W» and the button «» for opening the main menu are displayed.

In the middle of the screen there are readings of the parameters of the network to be measured (current and power of the load, voltage and frequency of the network).

The state of the load relay («on at 00:00») is located below.

At the bottom of the screen, there are counters of consumed electric power and the amount of fund spent.

Counter appearance:



- Reading for the current period
- Reading for the previous period

Note - the reading for the current period changes its color from green to red in case when the value of the current period exceeds the value of the previous period.





Fig.B2 – The state of the «EPS-Slave»

ELECTRICITY COUNTERS - meters of electric power consumed from the network for the last day, week and month.

FOR ALL TIME SINCE – meters of electric power for the whole time, starting from the moment of reset.

B3. Main menu

Pressing the «  » button will display the «EPS-Slave» main menu, as shown in Fig. B3.

To close the menu, press the «  » button again.

- «STATE» - the current state.
- «PROTECTION» - settings of protective functions.
- «LOG» - viewing the logbook.
- «SETTINGS» - basic settings.

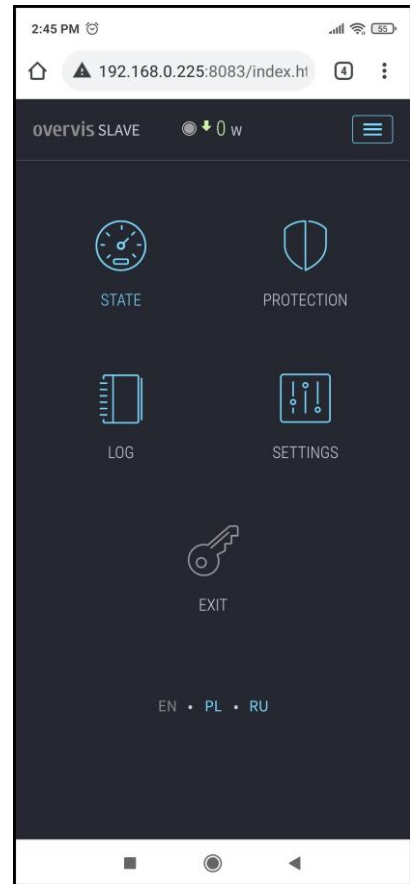

Fig. B3 – Main menu of the «EPS-Slave»

B4. Protection

It opens after navigating to a menu item «PROTECTION» (Fig. B4).

This menu item contains settings for voltage protection functions;

- **Upper threshold** – the maximum voltage value, upon reaching which the load will be disconnected;
- **Lower threshold** - the minimum voltage value, upon reaching which the load will be disconnected;
- **Re-switching on delay** - delay before reclosing the load after a failure
- **Save** – to save settings.

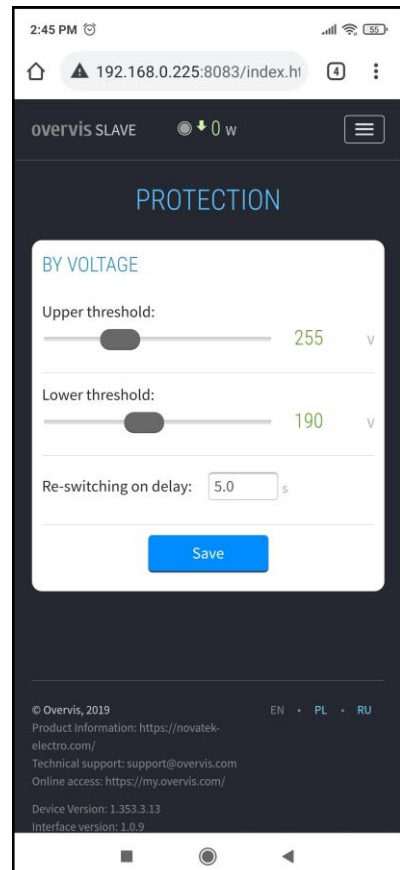

Fig. B4 – Voltage protection

B5. Settings

Opens after navigating to a menu item «SETTINGS» (Fig. B5).

This menu item contains the basic «EPS-Slave» settings, divided into groups:

- Access to the device;
- Electricity Cost;
- Wi-Fi;
- Date and time;
- Cloud Overvis;
- Additionally.

ACCESS TO THE DEVICE

- **Device Name** – name of the device;
- **Password** – gives a password of access to the «EPS-Slave» via the Web-interface;
- **Save** – to save settings of the group.

Wi-Fi

- **Network name (SSID)** - the name of the Wi-Fi network to which the «EPS-Slave» is connected;
- **Network password** - password of the Wi-Fi network to which the «EPS-Slave» is connected;
- **Enable automatic Wi-Fi restart every 8 hours;**
- **TCP/IP settings** - TCP/IP settings mode (manual or automatic DHCP);
- **IP address** - setting the IP address;
- **Subnet mask** - setting the subnet mask;
- **Default gateway** - setting the address of the default gateway;
- **DNS1** - main domain name server;
- **DNS2** - additional domain name server;

- **MAC address** - unique MAC address of the «EPS-Slave»;
- **IP address** - current IP address of the «EPS-Slave»;
- **Save** - save the group settings.

DATE AND TIME

- **Time on device** - current date and time on the «EPS-Slave»;

OVERVIS CLOUD

- **Enable remote access via the cloud** - whether the «EPS-Slave» connection to the Overvis cloud is allowed or denied;
- **Server address** - sets the address of the Overvis cloud;
- **Port** - connection port;
- **Status** - service information about the status of connection to the Overvis cloud;
- **Save** - save group settings.

ADDITIONALLY

- **Indication brightness** - sets the brightness of the device indication glow;
- **Save** - save group settings.

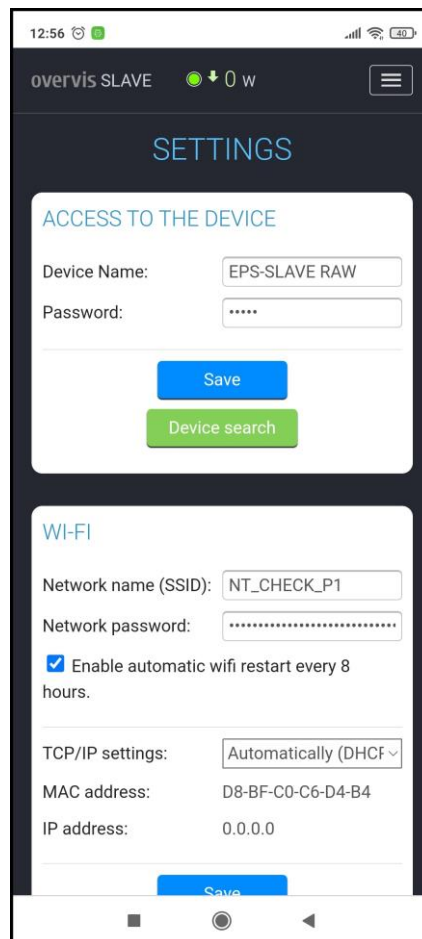

Fig. B5 – basic settings of the «EPS-Slave»

Table B1 – Adjustable parameters of «EPS-Slave»

Name	Range		Value after reset
	from	to	
Network name (SSID)	32 ASCII symbols		empty
Network password	64 ASCII symbols		empty
TCP/IP settings	Manually/automatically		automatically
IP address	0.0.0.0	255.255.255.255	192.168.0.105
Subnet mask	0.0.0.0	255.255.255.255	255.255.255.0
Default gateway	0.0.0.0	255.255.255.255	192.168.0.1
DNS1	0.0.0.0	255.255.255.255	208.67.222.222
DNS2	0.0.0.0	255.255.255.255	8.8.8.8
Voltage protection			
Upper threshold, V	240	290	255
Lower threshold, V	160	230	190
Delay of re-closure, s	0.5	600.0	5.0
Access to the device			
Name of the device	32 ASCII symbols		«EPS-Slave_XXXXXX»
Web access password	32 ASCII symbols		«admin»
Electricity cost			
Cost of 1kWh consumption	0.001	9999.9999	1.000
Cost of 1kWh generation	0.001	9999.9999	0.500
Currency	BYR, BGN, CZK, CHF, EUR, GBP, INR, KZT, LVL, LTL, MDL, PLN, PRB, RUB, RON, SEK, UAH, USD		EUR
«my.overvis.com» cloud			
Work authorization	Off/On		On
Server address	32 ASCII symbols		«my.overvis.com»
Port of connection	1	65535	20504
Additionally			
Brightness of indication	1	15	12